



SMART CLIMA

VIEW 
IoT smart life

**Temperature control systems,
simple and versatile.**

A responsible choice

for comfort while keeping energy consumption levels in check.

We have focused on the design of **solutions for managing central heating and air conditioning that can be controlled one room at a time or from a single device, in the form of stylish thermostats, integrated** in our product ecosystem for managing lights in various environments: at home, in the office or for the hospitality industry. To contribute to the general improvement of energy consumption levels, a responsible choice is a completely customised central heating system.



Efficiency and Savings

Central heating and domestic hot water use constitute 79% of the total energy consumption for household use. A smart thermostat heats and cools only when necessary. Various studies have demonstrated savings of up to 10% in central heating and up to 15% in air conditioning.

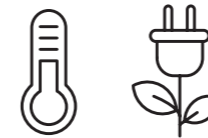

Comfort and well-being

Smart thermostats communicate with the air conditioner or boiler via app to obtain the right temperature at any time. They are easy to install and very discrete.



Environmentally-friendly

About one third of the world's energy consumption is caused by heating and air conditioning in buildings. Every single extra degree in temperature is the equivalent of a 7% rise in costs in your energy bill and greater CO₂ emissions into the environment. With the careful use of temperature control devices, consumption levels can be reduced, waste can be avoided and CO₂ emissions reduced.

Flush mounting solutions for **temperature control** and energy **efficiency**.



connected
touch thermostat

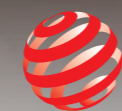

reddot winner 2021

Surface mounting solutions for **temperature control** and energy **efficiency**.



smart
thermostat



stand alone and connected
dial thermostat





Ease of use.

Connected thermostats are simple and intuitive.

Vimar temperature control products are ideal for any type of system, with a versatile and extensive range of functions: surface mounting and flush mounting thermostats, solutions that are stand alone solutions or connected in radio frequency or via Bus, to create the ideal climate in every environment and optimise the consumption levels of the entire building.

Local device control



Everything clearly under control with a simple touch

Mobile control

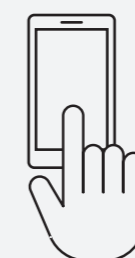

View app

Everything clearly under control with your mobile phone

Voice control

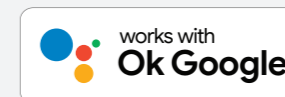
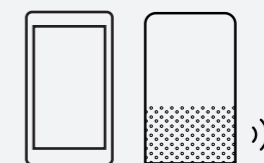

You can manage the central heating by voice using voice assistants. Google Assistant, Amazon Alexa, Siri (Apple)



Geolocation



When used in conjunction with voice assistants, you can set the geolocation routine, which allows you to save energy by switching off the heating when you leave your home.

Easy management of **temperature.**

Energy saving, as it only heats and cools when necessary.

With the connected thermostat, your energy consumption can be reduced by up to 30%. You can save more, with fewer temperature variations.



Manage and program your climate wherever you are with the View app.

Manage the central heating and air conditioning in your home wherever you are, whether out on the street or from the office, or from the comfort of your sofa.



View app

A comfortable temperature at all times.

Program the temperature according to your ideal climate: pre-heat or cool the rooms to the ideal temperature according to your lifestyle and your hours.



Every area in your home at just the right temperature.

You can manage the temperature in each room separately. Every room will always be at the desired temperature at the time you set.

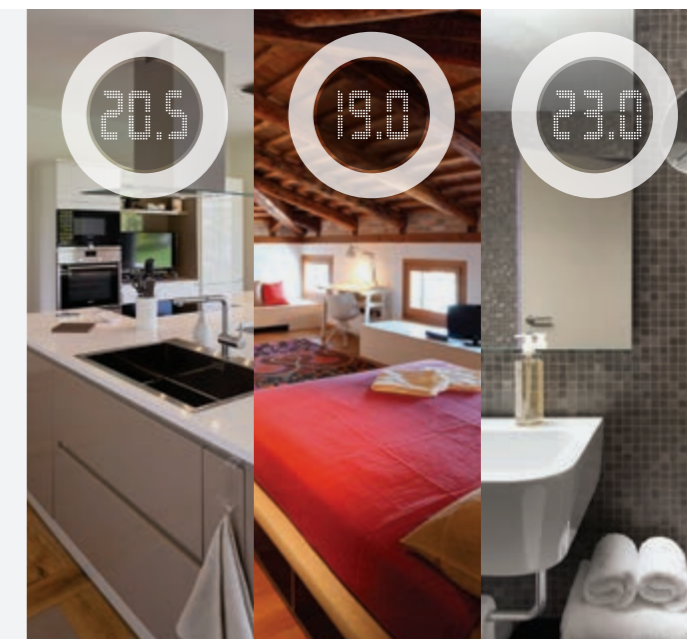

Easy integration. Suitable for any air conditioning and central heating system.

Vimar temperature control solutions are suitable for any heating system, with 2 or 4 pipes, either based on a condensation boiler or on a heat pump or on a VRV system, for both residential and tertiary use.





Having every area in your home at just the right temperature.



Flush mounting Eikon Tactil thermostat

Flush mounting dial thermostat with Arké cover plate

Surface mounting Smart thermostat

A single app. To manage the electrical system of one or more connected homes.

In addition to the connected thermostat, you can use the View app to manage the electrical system in your home, activating and personalising scenarios: controlling lights, operating roller shutters, controlling accesses and managing the loads connected to the socket outlets.

View app. Manage and program the temperature of your spaces, wherever you are.

With the View app, you can adjust the temperature in the various rooms across your home at any time, even when you are out, to control your energy consumption levels.

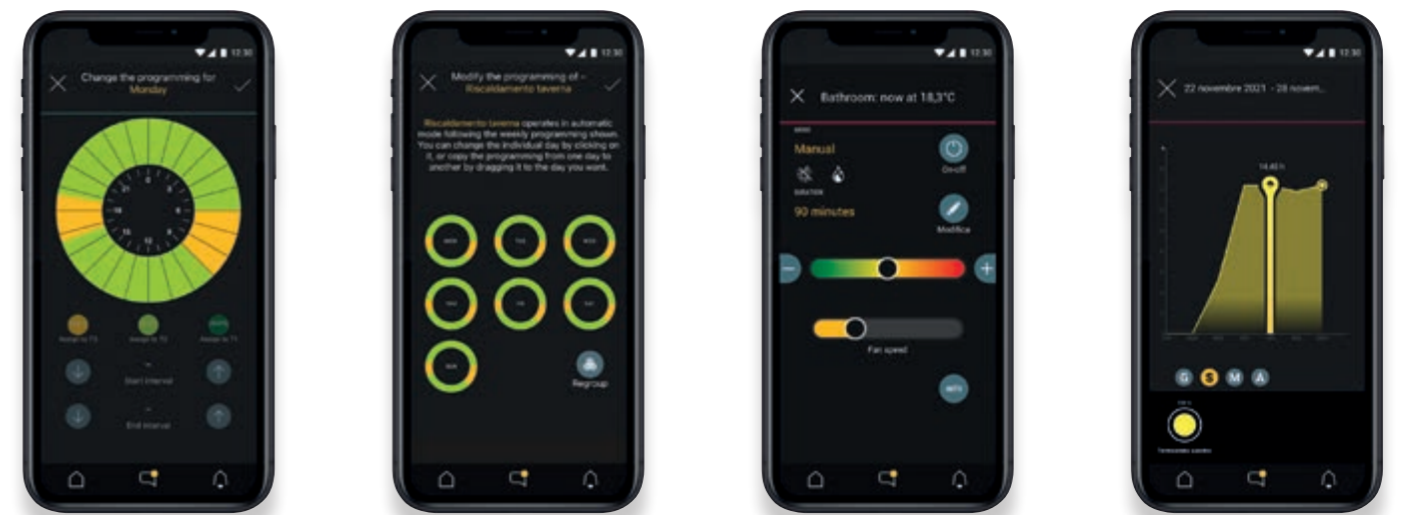

A snap to install

Download and install the View app, create your account, connect the thermostat to the Wi-Fi network in your home or office and start setting your programmes.

Set default

Programs according to your lifestyle, associate temperature thresholds with specific days or time brackets. When you go to bed, the program is already active. Set scenarios or temperature automatically: summer and winter.

Monitor consumption levels

Keeping the energy consumption levels of your home under control at all times is easy, with hourly, daily, weekly, monthly and even annual graphs.

Manage the thermostat from smartphones and various users

Manage several thermostats

In the same home or office.

“Drag and Drop” function

To set the temperature from one day to the next.

Flexible

You can control your entire home at any time, changing the temperature or the program set; setting the “turn everything off” function or the antifreeze function regardless of the program set.

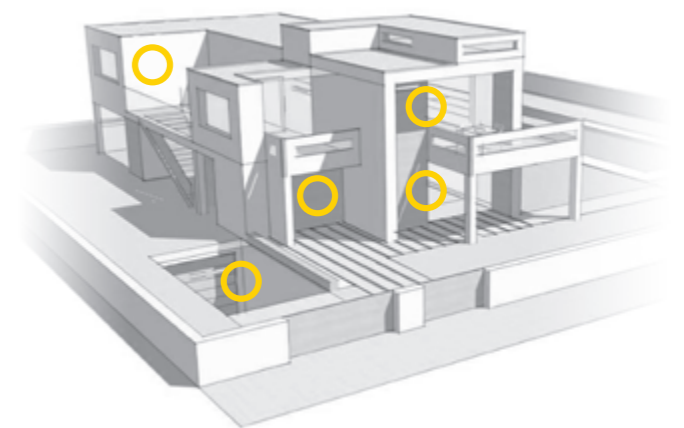



Eikon Tactil thermostat for flush mounting. Designed for high-level applications.

The new Eikon Tactil thermostat with touch display. Completeness and maximum comfort for the residential and hospitality sector. The Vimar range of thermostats has been supplemented with the stylish and sophisticated tactil version, available in black or white, for installation in mounting boxes with either 2 or 3 modules. Fitted with intuitive controls and a large touch display with RGB backlighting to encourage maximum readability, it blends in perfectly with home automation systems featuring By-me Plus and KNX technology.





Eikon Tactil thermostat for flush mounting.

The exclusive element that enhances your comfort levels.

Precious, easy to use, simple and versatile for any application, in high-level residential and commercial buildings with home&building automation systems



Scenario
DND/MUR
Fan Speed
(3 different order codes)

LED matrix display with ambient temperature

Proximity
(wake-up from stand-by)

ON/OFF
push button



Temperature setpoint

Four digital sensors

Gesture controls (without contact)
Vertical scrolling
Horizontal scrolling



Ambient Brightness
(automatic LED intensity control)



RGB LED backlighting
you can choose the colour you want for the symbols

Sensitive to your presence
The proximity sensor brings the display to life as soon as you come near the device. The controls light up, ready for your touch.



Gesture controls
Swipe vertically to edit the temperature set point.

Swipe horizontally to display the temperature in °F or the relative humidity rating in sequence (and then the temperature in °C).

Perfect co-ordination. The future takes shape.

A technological jewels pure as a diamond for Eikon Tactil perfectly coordinated with Eikon Evo devices, an exquisite elegance in your life.



Eikon Tactil thermostat



Eikon Tactil thermostat



Eikon Tactil - Control



Eikon Tactil - Control



Eikon Evo - Socket outlets



Eikon Evo - Socket outlets

Rotary dial thermostat for flush mounting.

Easy to use, simple and versatile,
for any application.

Truly one of a kind, extremely simple to use and highly customisable in its shapes, colours and materials, to blend in seamlessly with any interior design and architectural style.



Rotary dial thermostat for flush mounting.

Climate control across all your environments is connected to your lifestyle, wherever you may be.

Direct and elemental, fitted with four quick buttons on either side: on/off, hot/cold mode selection (for the scenario activation home automation system version), LED brightness selection, temperature measurement unit selection (°C or °F), a **LED matrix display** designed to be perfectly comprehensible even a few metres away and a **rotary ring** that can even be adjusted with a finger.

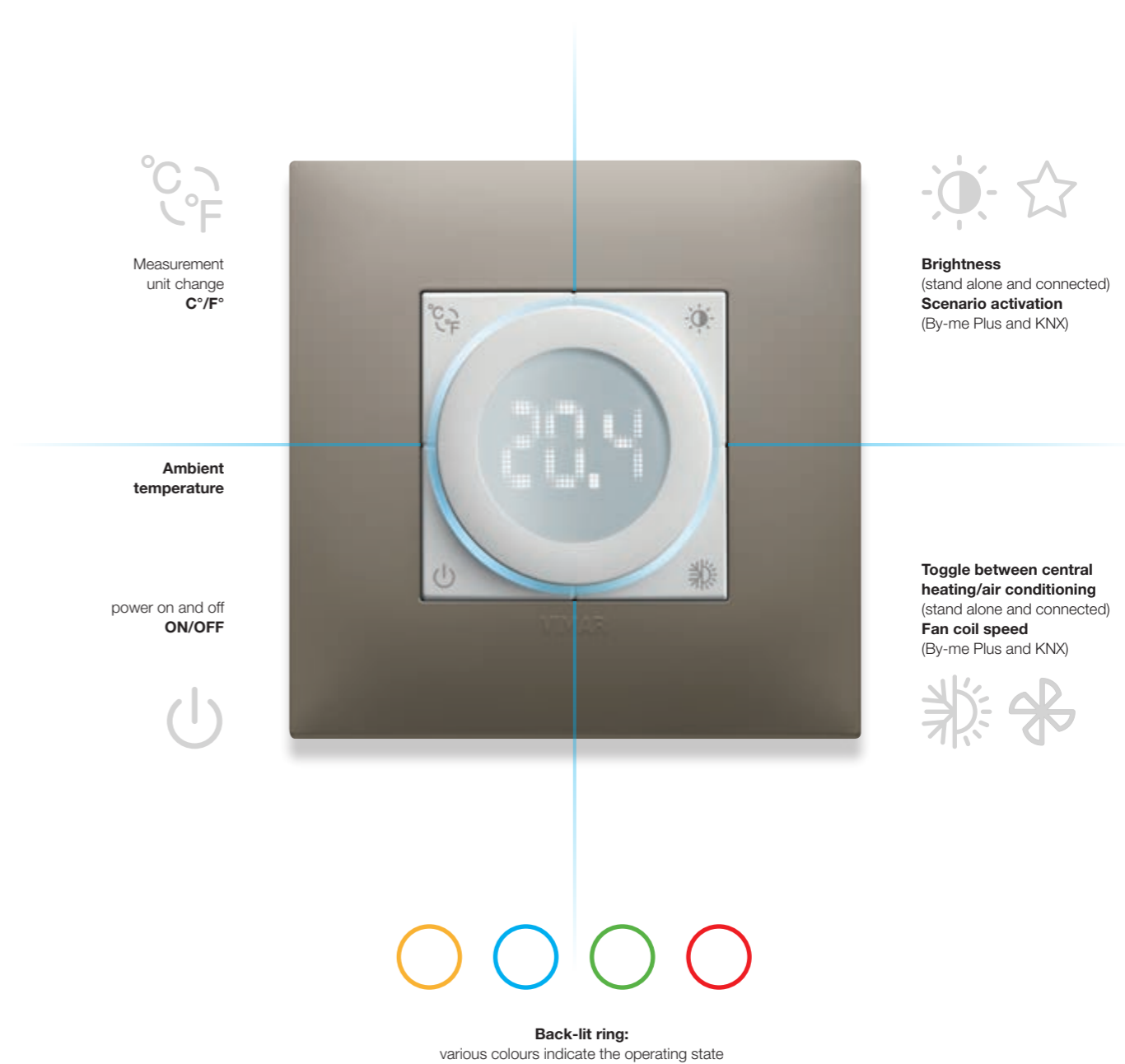

Versatile solutions for your projects.

Choose from our different top quality finishes: glass, leather, wood, stoneware, metals.

Match your style.

More than 120 combinations including the “Total Look” style.



Eikon Exé



Eikon Exé



Eikon Exé



Arké



Plana



Neve Up

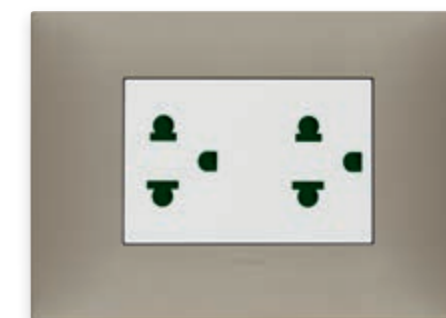
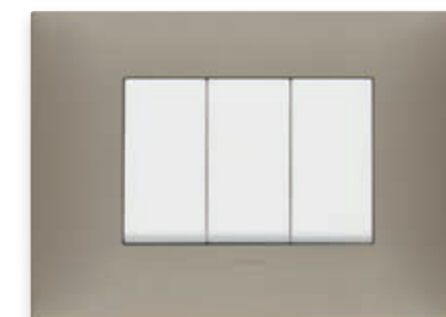

Smart thermostat for surface mounting.

Essential design
for every living styles.

The new smart thermostat for surface mounting is always connected to your lifestyle.
With built-in Wi-Fi or 4G LTE, it is very simple to use and the large white LED display provide to make it versatile.



Smart thermostat for surface mounting.

Simple and versatile,
within everyone's reach.

The **smart** thermostats with integrated **Wi-Fi** or **4G LTE** manage and program the temperature by means smartphone and tablet thanks to the **View app** or **by voice**.



Cloud connection
Wi-Fi connection



LED power
LED for system ON

Display with rocker movement for manual adjustment of temperature and **animated** white LEDs for an easy reading



Cloud connection
Data connection



LED power
LED for system ON
LED for auxiliary output

Slim profile
20,5 mm (Wi-Fi)
23,5 mm (4G)



Animated interface

User-friendly display with animated white LEDs to visualize heating mode (upward animation) or air-conditioning (downward animation)

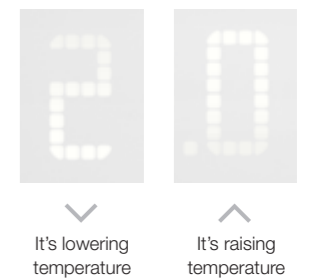



The ideal thermostat for every application and technology.

With the dial version of the thermostat, a single solution for various electrical system requirements: stand alone, Bluetooth® wireless technology connected, By-me Plus or Well-contact Plus for KNX. **Eikon Tactil version** is suitable for By-me Plus or KNX systems, too.

Stand alone

Simple and direct with on-board relays

View Wireless and Smart

Compatible with Vimar or third-party smart systems

By-me Plus

Integration in the new View IoT smart systems platform

Well-contact Plus KNX

Full integration with world standard automation protocol

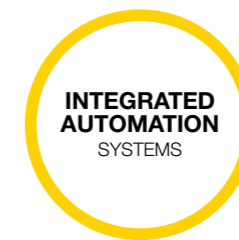

View app



View app



By web KNX app



Raise the temperature to 21°C

View Wireless system, smart control of lights, climate and roller shutters.

The easiest to design and install.



View Wireless. To create a smart system, simply have devices that have been designed specifically to be able to liaise with one another installed and then link up to the Wi-Fi network in your home or office via the gateway. All the smart controls (socket outlets or 1-way switches) continue to work in a conventional way too if you wish. The gateway is the heart of the smart system: it receives signals from all the connected devices and makes possible the connection with your Wi-Fi router.

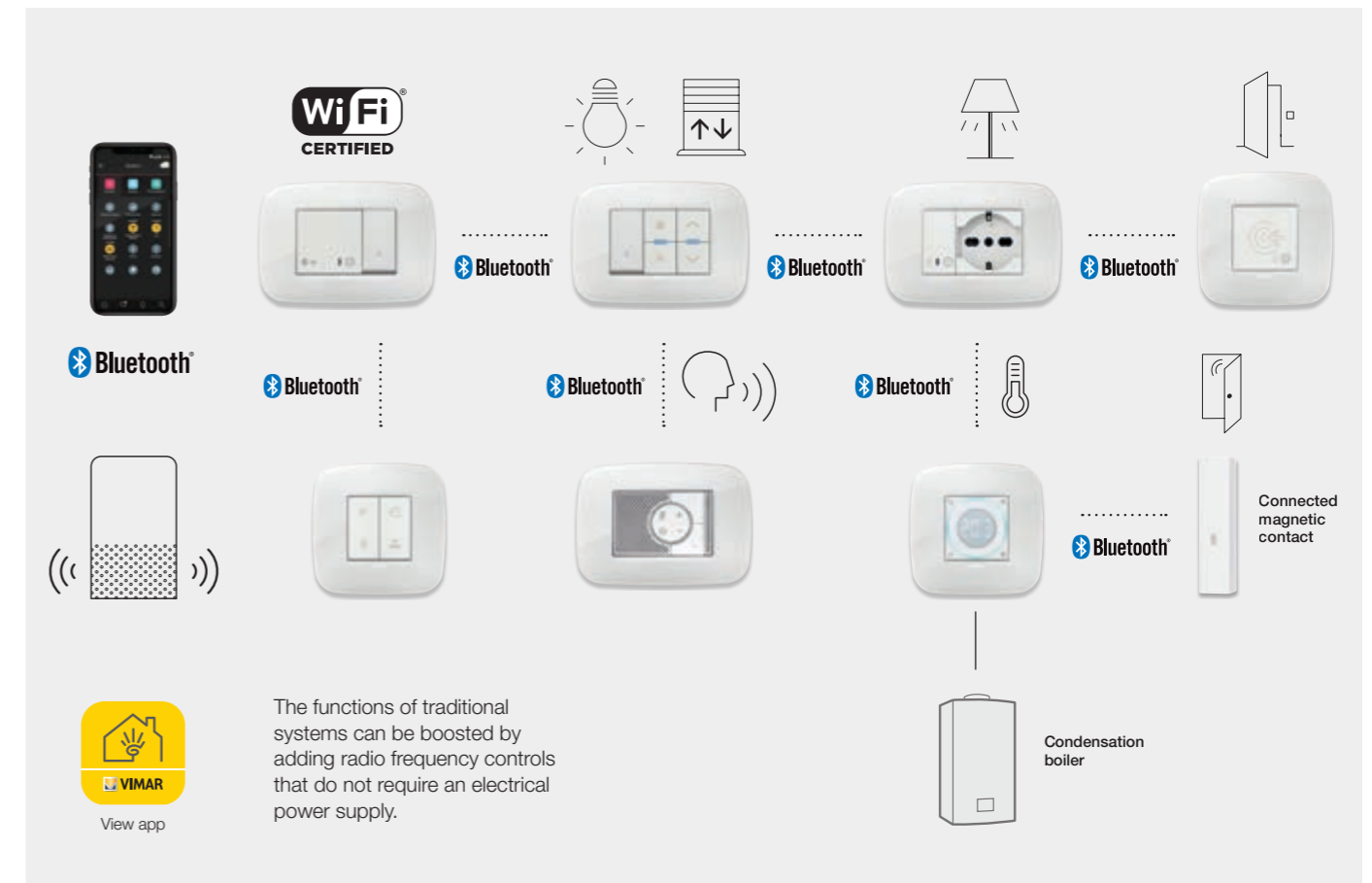



By-me Plus home automation system.

Energy efficiency, safety and comfort work hand in hand.



An integrated and modular solution. The functions liaise with one another in a comprehensive and constant way, with centralised supervision to optimise energy consumption and comfort levels. Flexible installation, speedy configuration, maximum integration also with the Vimar video door entry and security system. It is ideal anywhere, from an apartment to a villa, an office or even a hotel.

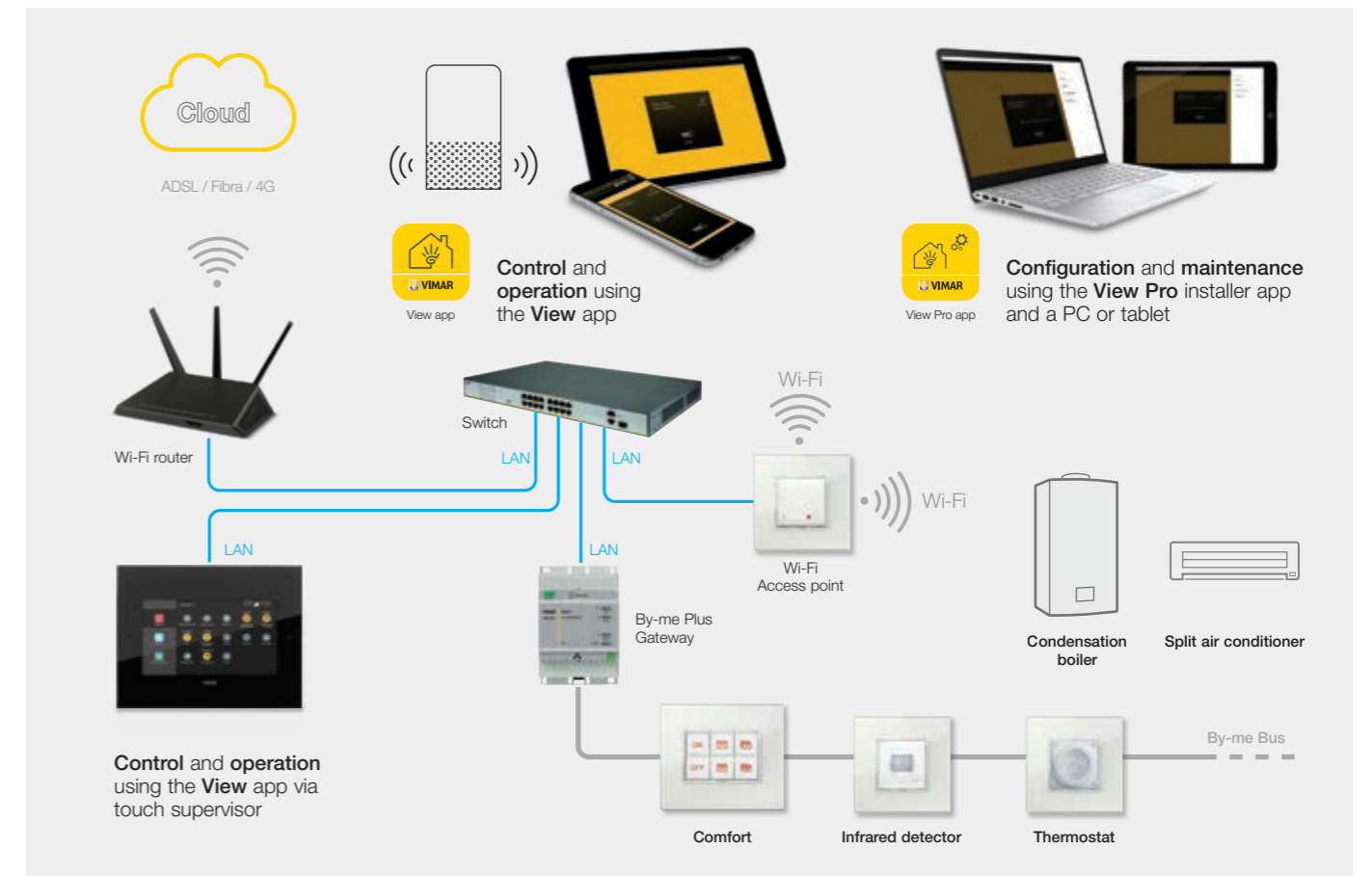



Well-contact Plus building automation system.

Perfect integration with KNX protocol.



Comprehensive building management. Well-contact Plus is developed on the KNX standard: a common platform to interact with products from various manufacturers. Ideal for accommodation facilities, offices, gyms, public amenities such as schools, museums or multi-purpose centres. More efficiency and safety.

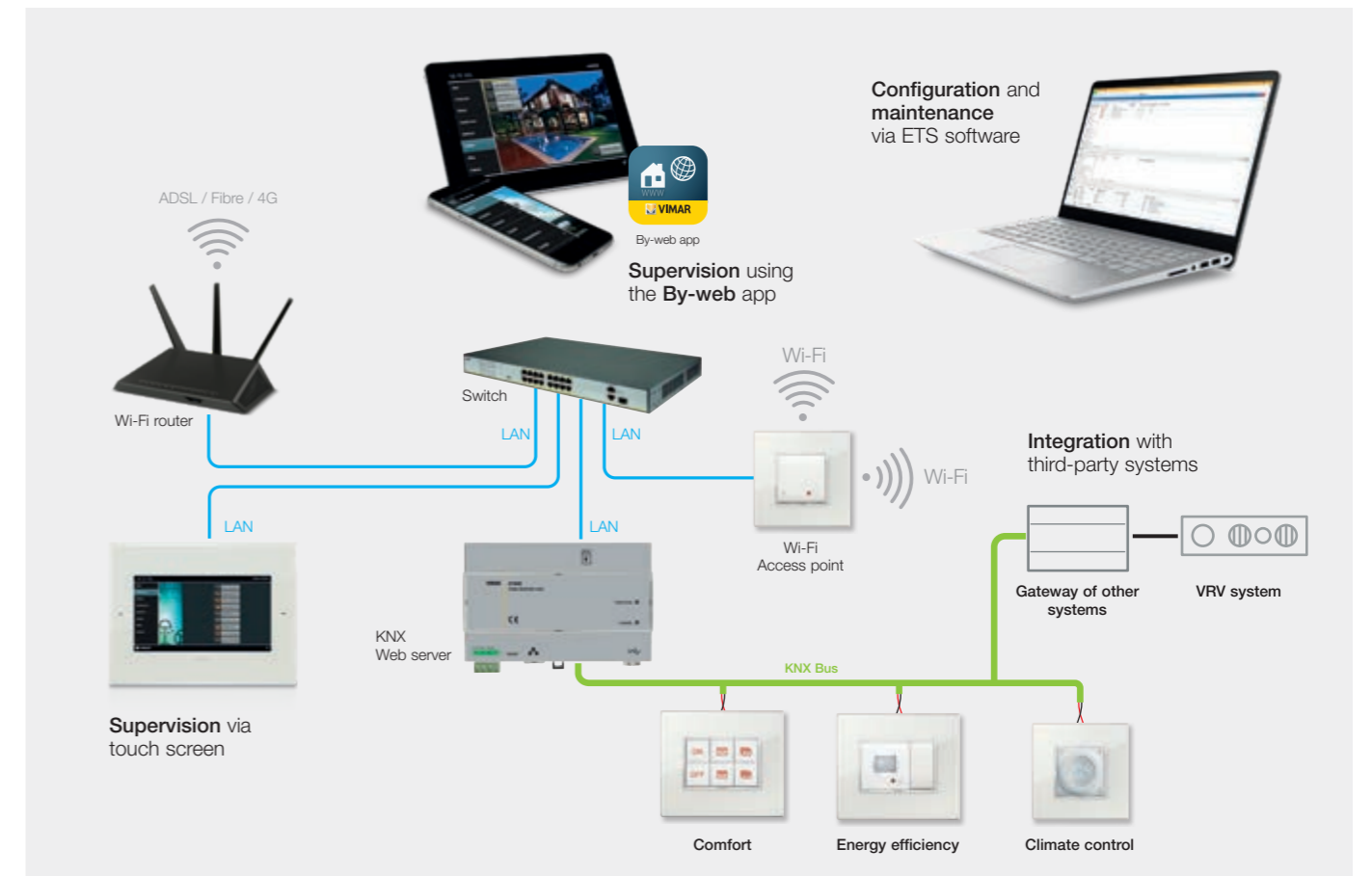

Index

TYPICAL INSTALLATIONS

from page 36

FLUSH MOUNTING STAND ALONE THERMOSTATS

from page 46

SURFACE MOUNTING SMART THERMOSTATS

from page 48

FLUSH MOUNTING VIEW WIRELESS THERMOSTATS  **Bluetooth®**

from page 52

FLUSH MOUNTING BY-ME PLUS THERMOSTATS



from page 56

FLUSH MOUNTING WELL-CONTACT PLUS THERMOSTATS



from page 60

Surface mounting smart thermostats.

The Wi-Fi and 4G LTE connected thermostats allow to control the temperature by smartphone with the View app or by voice with Amazon Alexa and Google Assistant smart speakers. The configuration of the thermostat is realized by View app via Bluetooth® wireless technology.



Thanks to the multi-zone or multi-home management of the View app, you can decide to control the temperature of your holiday home or to manage multiple areas within the same home.

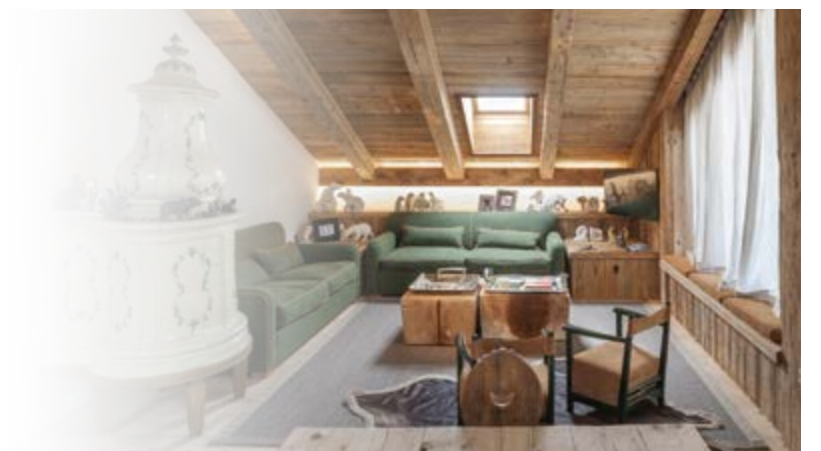
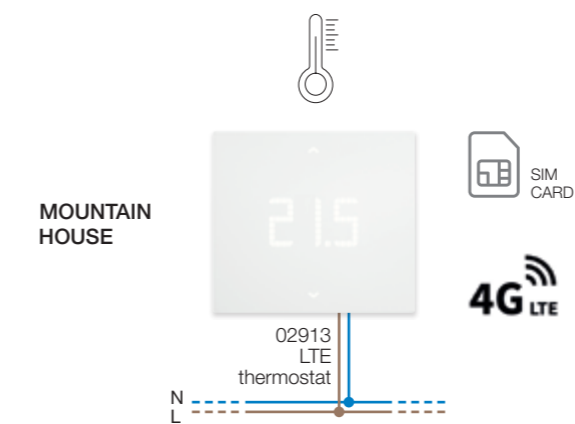
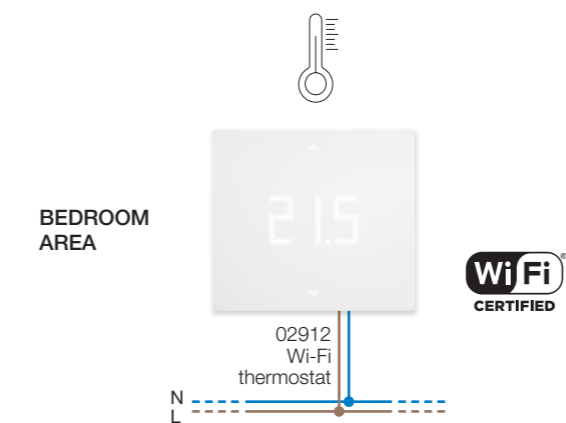
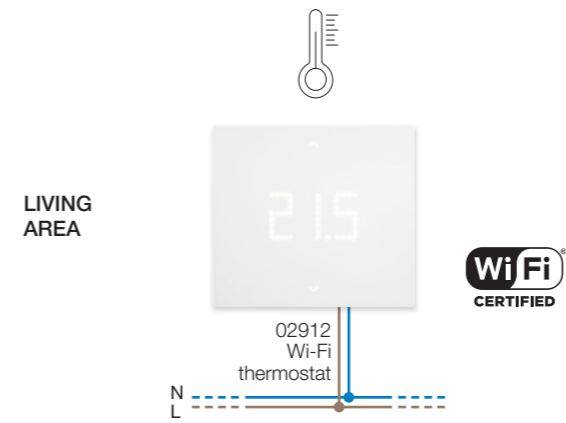

View Wireless temperature control.

The connected thermostat allows you to control the temperature not just from the front dial, but also from your smartphone or by voice using the Amazon Alexa, Google Assistant and Siri smart speakers (compatible with Apple Homekit). It can replace a traditional

thermostat and configuration is immediate using the View Wireless App and the Wi-Fi gateway. Moreover, with the connection to the magnetic contact, it activates/deactivates the temperature control system to minimise consumption and waste.

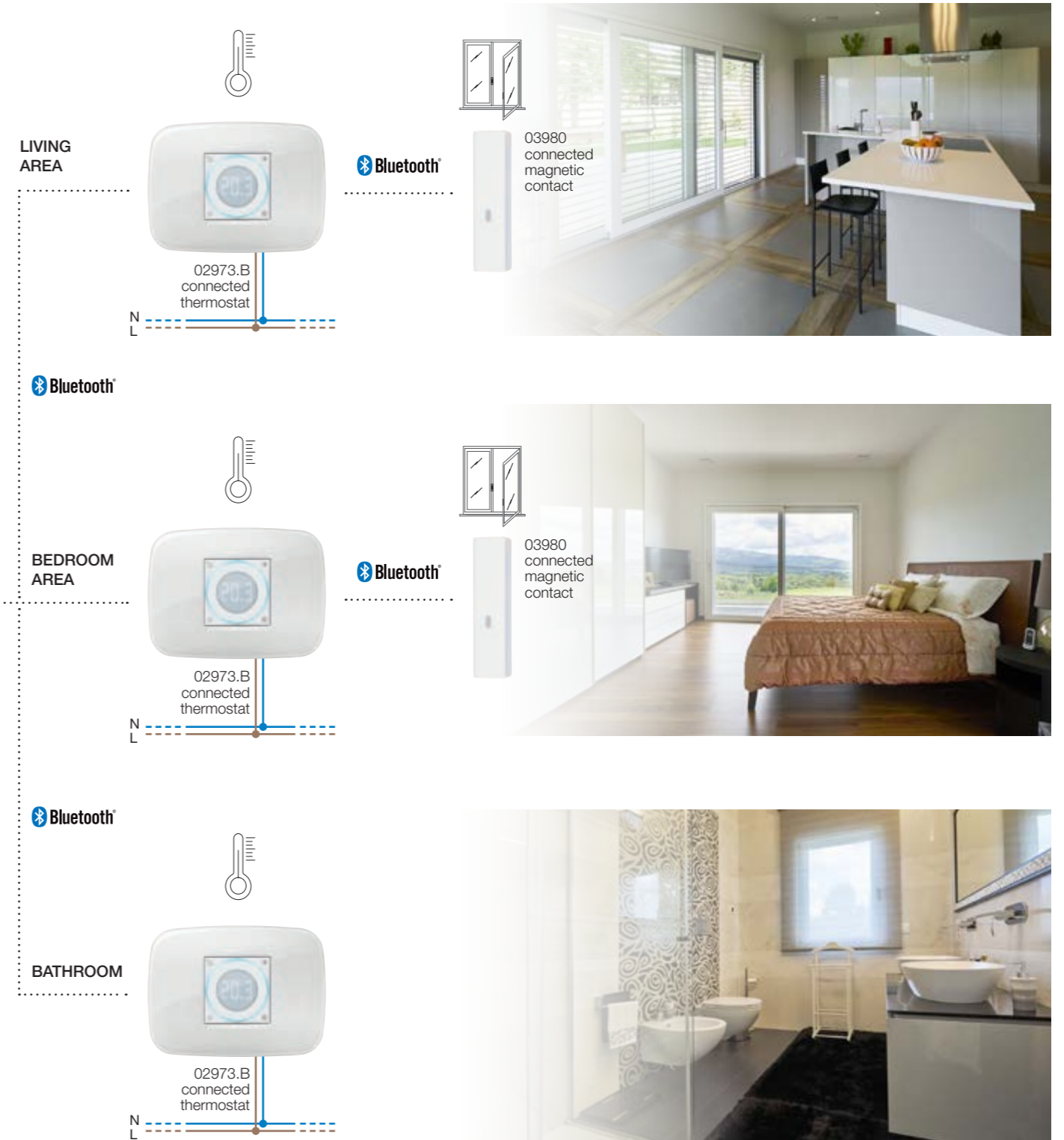

View Wireless: connected system based on Bluetooth® mesh system.

The **Bluetooth® wireless technology** standard makes it possible to use devices in a mesh network, whereby the gateway (20597, 19597 and 14597) is designed to allow the user **to control** the system **via the View app** both locally and remotely. Moreover, the system can also be controlled using Alexa, Google Assistant and Siri smart speakers and activate scenarios with Tab 5S Up and Tab 7S Up video entryphones. The installer **configures** the system in Bluetooth® wireless technology mode and sets all the parameters **using the View Wireless app**, which also allows the addition of battery-free remote controls, based on energy harvesting technology by EnOcean, for the activation of scenarios or the addition of other control devices.

System with connected devices for temperature, lights, roller shutter and consumption control. Up to 64 devices can be connected and up to 16 favourite scenarios can be set. Radio frequency devices can also be added to the system.

LIGHT AND ROLLER SHUTTER CONTROL AND SCENARIOS

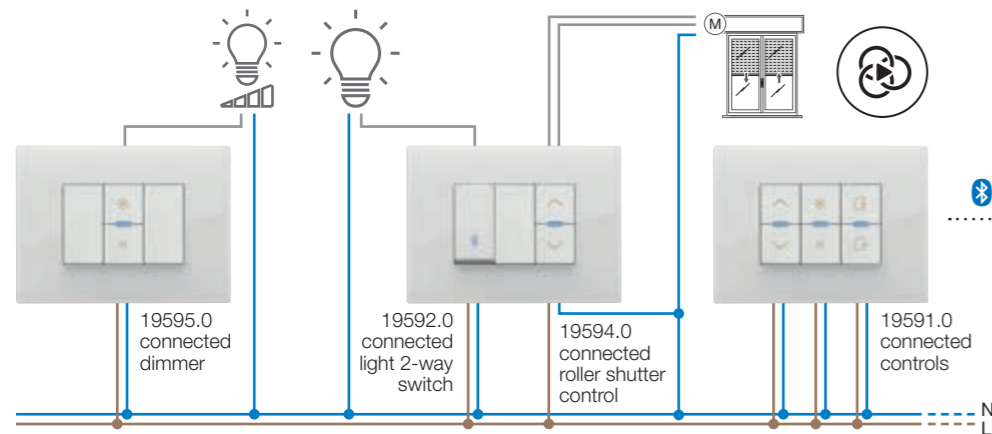

INTEGRATION WITH RADIO FREQUENCY CONTROLS



TEMPERATURE CONTROL

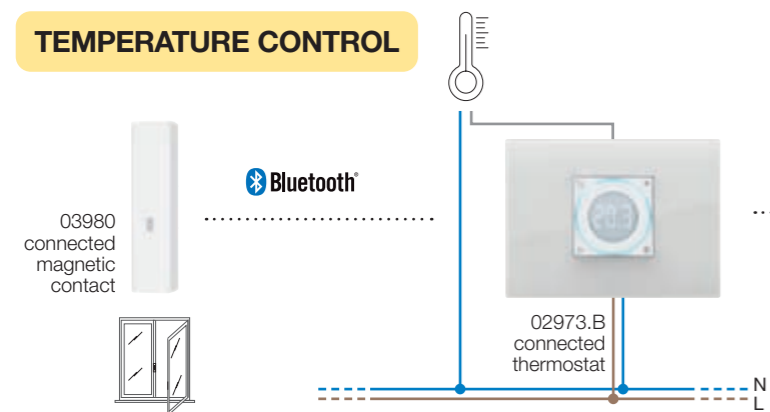

LOCAL AND VOICE CONTROL

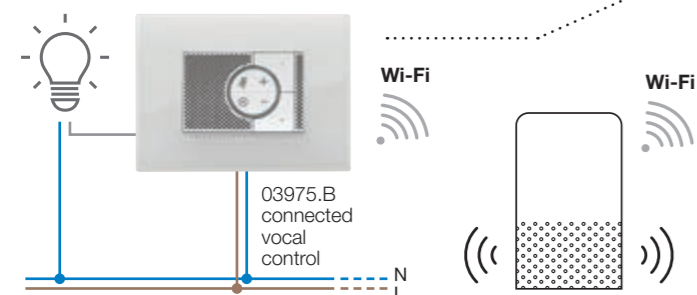

SCENARIOS ACTIVATION



The wiring of connected devices requires a power supply (L, N) and connection to the related loads and/or electro-mechanical control devices (2-way switches, 1-way switches, push buttons). The presence of Wi-Fi Internet connection is always required, to allow the connection to the Cloud for supervision (local and remote) and for integrations with the Alexa, Google Assistant and Siri smart speakers. The system is compatible with IFTTT. Recipes/applets can therefore be created, involving climate control, also integrating IFTTT compatible third-party devices. For instance, on reaching a specific internal temperature, you can turn on the air conditioning using a third-party IR interface.

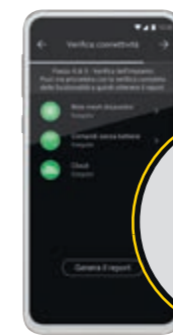

Configuration

Bluetooth

Bluetooth

Bluetooth

Bluetooth



ENERGY MANAGEMENT

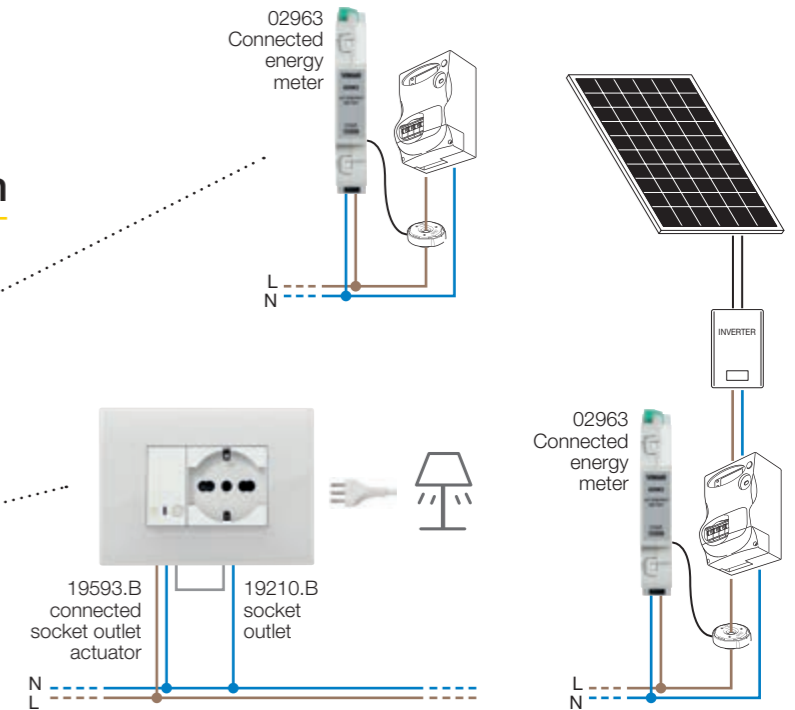

ACCESS CONTROL

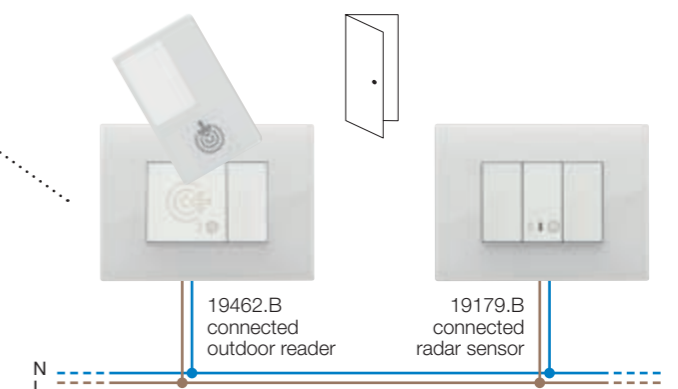

Use
local and remote

By-me Plus temperature control.

By-me Plus enables a smart control of temperature, managing the heating/cooling system centrally, programming the individual zones by time slot, monitoring consumption in real time - including water and gas - and reporting any exceeding optimal values. The energy produced by any photovoltaic system is also intelligently managed and the annoying blackout due to overload is preven-

ted by disconnecting non-priority loads. Solutions that allow energy savings ranging from 30% to 60% depending on the functions implemented (report from IoT of Politecnico of Milan - Italy and according to EN 15232 Standard).

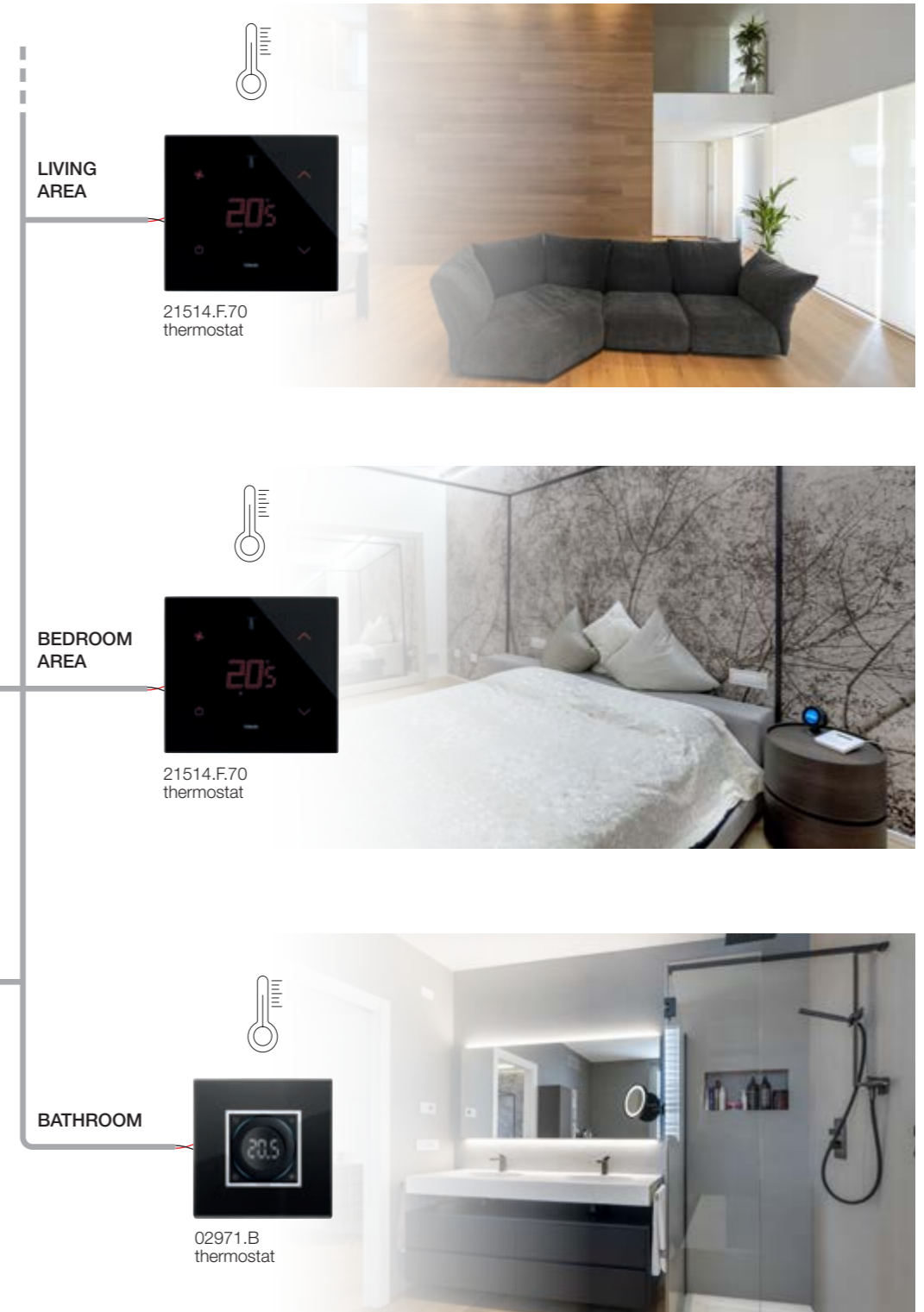

Well-contact Plus temperature control.

The accommodation facilities find in this solution, designed on the KNX standard, the answer to all efficiency and optimization needs. The system allows you to automate an infinite number of rooms; to supervise the climate, lights, shutters, check-in/check-

out management, access control directly from the PC of reception, as well as centrally control all the other areas of the hotel and integrate with third-party systems through the KNX protocol. Functionality, safety and a lot of comfort throughout the structure.



Flush mounting stand alone thermostats

Stand alone rotary dial thermostat

The thermostat is fitted with a front dial to adjust the setpoint (between 4°C and 40°C) and a central display with white LED backlit which shows, using the dial, the measured temperature setpoint. The rotary dial is marked by a backlit circular ring, which displays all the thermostat status. In addition, 4 front buttons for on/off, °C/°F units, display brightness and heating/cooling mode.

Technical specifications

- rated supply voltage: 100-240 V~, 50/60 Hz;
- max. power absorption from the mains: 1,5 VA;
- terminals:
 - 2 terminals (L and N) for line and neutral
 - 2 for relay output
- relay output with voltage-free contact: 5(2) A 240 V~;
- current settable setpoint: 4 °C - 40 °C;
- for use for Heating/Air Conditioning (winter/summer);
- Operating modes: Manual, Off;
- temperature control algorithms: On/Off;
- 4 front buttons for control and settings;
- RGB LED for output status signalling;
- operating temperature: T40 (0 °C +40 °C) (indoor use);
- protection degree: IP30;
- ErP classification (EU Reg. 811/2013): - ON/OFF: class I, contribution 1%;
- device in class II.

Operation

By means the rotary dial and 4 front buttons it is possible:

- heating/cooling set (winter/summer);
- change brightness;
- change the scale of the degrees;
- set the temperature in manual operation.

The circular ring, by means the LEDs, shows:

- LED off: device/ system OFF;
- LED on: heating/cooling system ON;
- lower left LED on: the device in ON but heating/cooling system is OFF because the temperature setpoint is reached.

Conformity to Standard

RED directive, RoHS directive, ErP directive, EN 60730-2-9, EN 63000 standards.
Temperature control device regulation (EU) no. 811/2013.
REACH (EU) Regulation no. 1907/2006 – Art. 33. The product may contain traces of lead.

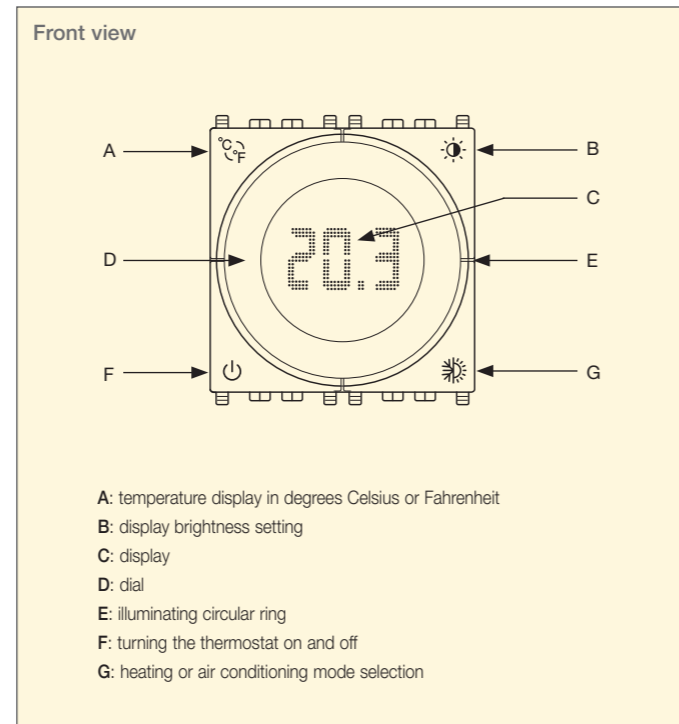
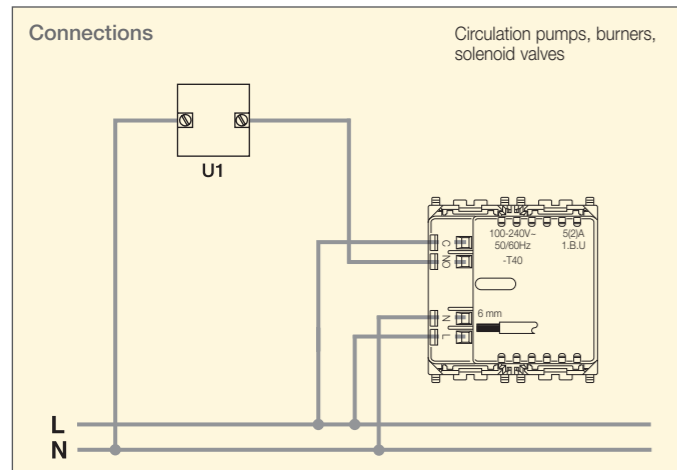

Flush mounting stand alone thermostats

Stand alone rotary dial thermostat

Rotary dial thermostat with relay output 5(2) A 240 V~, heating and air conditioning in ON/OFF mode, class I temperature control device (contribution 1%), white LED backlighting with brightness control, 100-240 V 50/60 Hz power supply - 2 modules. To be completed with **Eikon**, **Arké** and **Plana** cover plates, for **Idea** with dedicated mounting frame 16723



Example of installed thermostat



Stand alone rotary dial thermostat

Rotary dial thermostat with relay output 5(2) A 240 V~, heating and air conditioning in ON/OFF mode, class I temperature control device (contribution 1%), white LED backlighting with brightness control, 100-240 V 50/60 Hz power supply - 2 modules

NEVE UP



Example of installed thermostat



Neve Up

Surface mounting connected Wi-Fi thermostat

The thermostat enables manually or via View app the remote control of room temperature (heating / air conditioning) via View app and with Amazon Alexa and Google Assistant voice controls. Configuration is realized with View app via Bluetooth® wireless technology, without configuration the device is ready to operate manually as a normal thermostat.

Technical specifications

- rated supply voltage: 100-240 V~, 50/60 Hz;
- consumption at 100 V~:
 - brightness L1 (low) and relay OFF 0,3 W;
 - brightness L3 (high) and relay ON 0,85 W;
- consumption at 240 V~:
 - brightness L1 (low) and relay OFF 0,5 W;
 - brightness L3 (high) and relay ON 1 W;
- RF transmission power: < 100 mW (20 dBm);
- frequency range: 2400-2483,5 MHz;
- terminals:
 - 2 (L and N) for line and neutral;
 - 2 for digital input 120 - 240 V~ for alarm signalling (for instance boiler shutdown)
- Maximum length of the 30 m contact connection cable;
 - 2 (NO-C) for relay output with voltage-free contact: 5(2) A 240 V~;
- 2 front buttons with rocking action for control and settings;
- 1 button (positioned at the bottom) for configuration and reset;
- side LEDs:
 - 2 on the left for signalling Cloud and Wi-Fi connection;
 - 2 on the right for signalling ON/OFF and relay state;
- white LED display for displaying temperature, set point and configuration state signalling;
- current settable setpoint: 4 °C ÷ 40 °C;

- temp. measurement precision (integrated probe): 0,5°C between +15°C and 30°C, 0,8°C at the extremes;
- for use for Heating/Air Conditioning (winter/summer);
- operating modes: Automatic, Manual, Reduction, Absence, Protection, Off, Timed Manual;
- temperature control algorithms: configurable PID or ON/OFF;
- operating temperature: T40 (0 °C ÷ +40 °C) (indoor use);
- protection degree: IP20;
- ErP classification (EU Reg. 811/2013):
 - ON/OFF: class I, contribution 1%;
 - PID: class IV, contribution 2%;
- device in class II;
- room temperature display: 0 °C +40 °C;
- hysteresis adjustable via app: from 0,1 °C to 1 °C;
- hourly temperature setting (via app);
- configuration via View app using Bluetooth technology;
- controllable via View app, Amazon Alexa and Google Assistant voice assistants.

Conformity to Standard

RED directive, RoHS directive, ErP directive, standards EN 60730-2-7, EN IEC 60730-2-9, EN 300 328, EN 301 489-17, EN 62311, EN IEC 63000. Temperature control device regulation (EU) no. 811/2013. Vimar SpA declares that the radio equipment complies with Directive 2014/53/EU. The full text of the EU declaration of conformity is on the product sheet available on the following website: www.vimar.com REACH (EU) Regulation no. 1907/2006 – Art. 33. The product may contain traces of lead.

Surface mounting connected Wi-Fi thermostat

Electronic Wi-Fi thermostat for local control and management of temperature (heating and air-conditioning) by View app, in ON/OFF and PID modes, class I temperature control device (contribution 1%) in ON/OFF mode, class IV (contribution 2%) in PID mode, configuration with View app via Bluetooth wireless technology, 1 digital-input, 1 5(2) A 240 V~ relay output, supply voltage 100-240 V~ 50/60 Hz, white LED backlighting, for surface mounting, white



02912

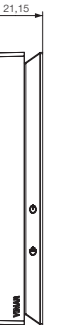

View app

Front and side view

<ul style="list-style-type: none"> • Short press = adjustment of set point from 4°C to 40°C in steps of 0.5°C • Long press (5 s) = if on standby the thermostat is switched off; if switched OFF the thermostat is switched on 	
<p>Display</p> <ul style="list-style-type: none"> • bt = thermostat in Bluetooth configuration • off = thermostat off; on = thermostat on • °C = degrees Celsius; °F = degrees Fahrenheit • animation from the bottom up = Heating • animation from the top down = Air conditioning • Rst = thermostat reset • PIN = PIN entry prompt • Alr, Con, Cld, etc. = alarms 	
<ul style="list-style-type: none"> • Short press = degrees Celsius/Fahrenheit selection • Long press (5 s) = the thermostat enters the configuration phase (bt) • Prolonged press (30 s) within the first 5 min of powering = thermostat reset (Rst) 	

LED indications	
	<ul style="list-style-type: none"> • ON green = Cloud correctly connected • ON red = Cloud not connected
	<ul style="list-style-type: none"> • ON green = Wi-Fi correctly connected • ON red = Wi-Fi not connected
	<ul style="list-style-type: none"> • ON green = ON thermostat • OFF = OFF thermostat
	<ul style="list-style-type: none"> • ON white = Active relay

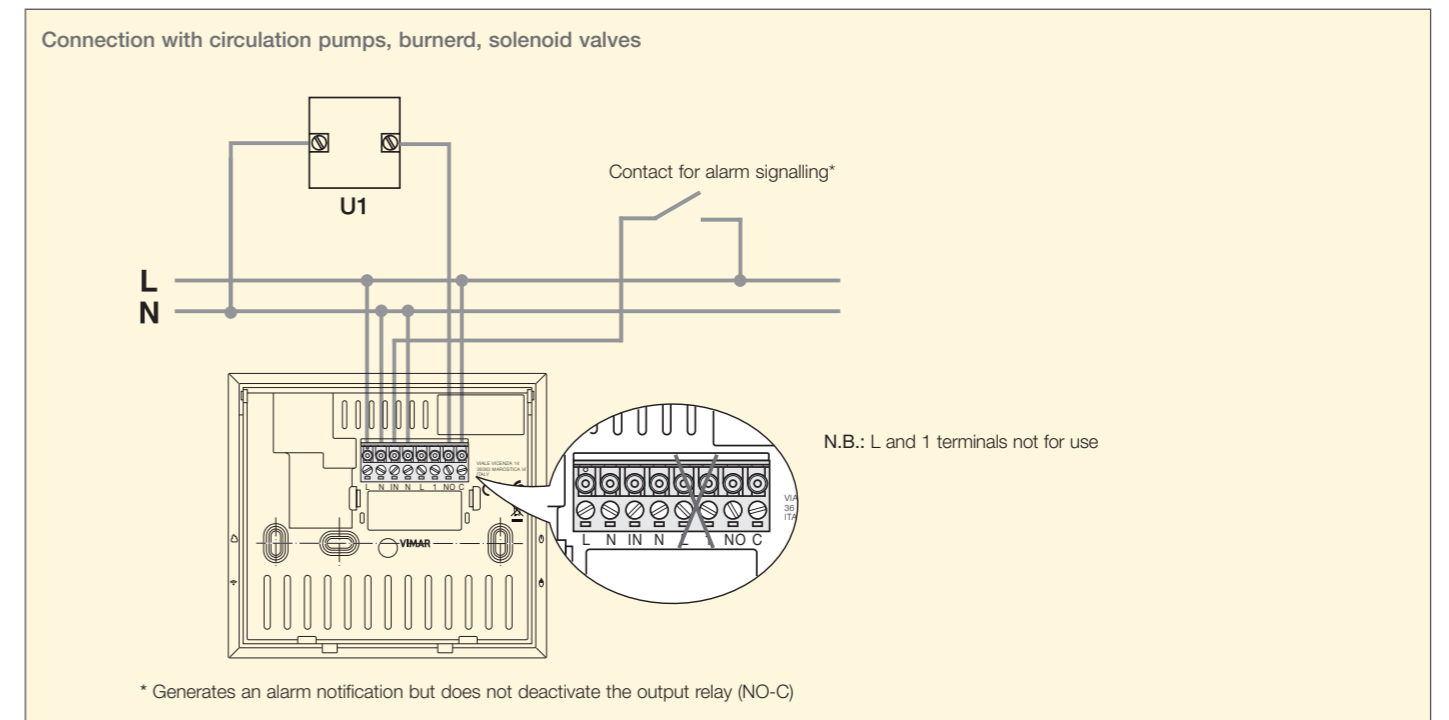

Surface mounting connected LTE thermostat

The thermostat enables manually or via View app the remote control of room temperature (heating / air conditioning) via View app and with Amazon Alexa and Google Assistant voice controls. Configuration is realized with View app via Bluetooth® wireless technology, for the connection it is necessary a SIM CARD (not supplied), without configuration the device is ready to operate manually as a normal thermostat.

Technical specifications

- rated supply voltage: 100-240 V~, 50/60 Hz;
 - consumption at 100 V~:
 - brightness L1 (low) and relay OFF 0,3 W;
 - brightness L3 (high) and relay ON 0,85 W;
 - consumption at 240 V~:
 - brightness L1 (low) and relay OFF 0,5 W;
 - brightness L3 (high) and relay ON 1 W;
 - Bluetooth technology:
 - RF transmission power: < 100 mW (20 dBm);
 - frequency range: 2400-2483,5 MHz;
 - transmission bands: B1 (2100 MHz), B3 (1800 MHz), B7 (2600 MHz), B8 (900 MHz), B20 (800 MHz);
 - terminals:
 - 2 (L and N) for line and neutral;
 - 2 for digital input 120-240 V~ for alarm signalling (for instance boiler shutdown)
- Maximum length of the 30 m contact connection cable;
- 2 (NO-C) for relay output with voltage-free contact: 5(2) A 240 V~;
 - 2 for output 100 mA 120-230 V~ to control an auxiliary relay (for instance to switch a boiler or a light on/off);
- 2 front buttons with rocking action for control and settings;
 - 1 button (positioned at the bottom) for configuration and reset;
 - side LEDs:
 - 2 on the left for signalling Cloud connection and LTE network connection;
 - 3 on the right for signalling ON/OFF, relay state and auxiliary output state;

- white LED display for displaying temperature, set point and configuration state signalling;
- current settable setpoint: 4 °C ÷ 40 °C;
- temperature measurement precision (integrated probe): 0,5°C between +15°C and 30°C, 0,8°C at the extremes;
- for use for Heating/Air Conditioning (winter/summer);
- operating modes: Automatic, Manual, Reduction, Absence, Protection, Off, Timed Manual;
- temperature control algorithms: configurable PID or ON/OFF;
- operating temperature: T40 (0 °C ÷ +40 °C) (indoor use);
- protection degree: IP20;
- ErP classification (EU Reg. 811/2013): - ON/OFF: class I, contribution 1%. - PID: class IV, contribution 2%.
- device in class II;
- room temperature display: 0 °C +40 °C;
- hysteresis adjustable via app: from 0,1 °C to 1 °C;
- hourly temperature setting (via app);
- room temperature during transportation: -25 °C +60 °C;
- clock error: ≤ 1 s per day;
- configuration via View app using Bluetooth technology;
- controllable via View app, Amazon Alexa and Google Assistant voice assistants.

Conformity to Standard

RED directive, RoHS directive, ErP directive, standards EN 60730-2-7, EN IEC 60730-2-9, EN 300 328, EN 301 489-17, EN 301 908-13, EN 301 489-52, EN 62311, EN IEC 63000.

Temperature control device regulation (EU) no. 811/2013. Vimar SpA declares that the radio equipment complies with Directive 2014/53/EU. The full text of the EU declaration of conformity is on the product sheet available on the following website: www.vimar.com

REACH (EU) Regulation no. 1907/2006 – Art. 33. The product may contain traces of lead.

Front and side view

<ul style="list-style-type: none"> • Short press = adjustment of set point from 4°C to 40°C in steps of 0.5°C • Long press (5 s) = if on standby the thermostat is switched off; if switched OFF the thermostat is switched on 	<p>Display</p> <ul style="list-style-type: none"> • bt = thermostat in Bluetooth configuration • off = thermostat off; on = thermostat on • °C = degrees Celsius; °F = degrees Fahrenheit • animation from the bottom up = Heating • animation from the top down = Air conditioning • Rst = thermostat reset • PIN = PIN entry prompt • Air, Con, Cld, ItE, etc. = alarms
<ul style="list-style-type: none"> • Short press = degrees Celsius/Fahrenheit selection • Long press (5 s) = the thermostat enters the configuration phase (bt) • Prolonged press (30 s) within the first 5 min of powering = thermostat reset (Rst) 	<p>LED indications</p> <ul style="list-style-type: none"> • ON green = Cloud correctly connected • ON red = Cloud not connected • ON green = LTE network connected • ON red = LTE network not connected • ON green = ON thermostat • OFF = OFF thermostat • ON white = Active relay • ON white = Auxiliary output active

Surface mounting connected LTE thermostat

Electronic LTE thermostat for local control and management of temperature (heating and air-conditioning) by dedicated app in ON/OFF and PID modes, class I temperature control device (contribution 1%) in ON/OFF mode, class IV (contribution 2%) in PID mode, configuration with View app via Bluetooth wireless technology, 1 additional output and 1 digital input, 1 5(2) A 240 V~ relay output, supply voltage 100-240 V~ 50/60 Hz, white LED backlighting, for surface mounting, white



02913

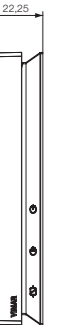

View app

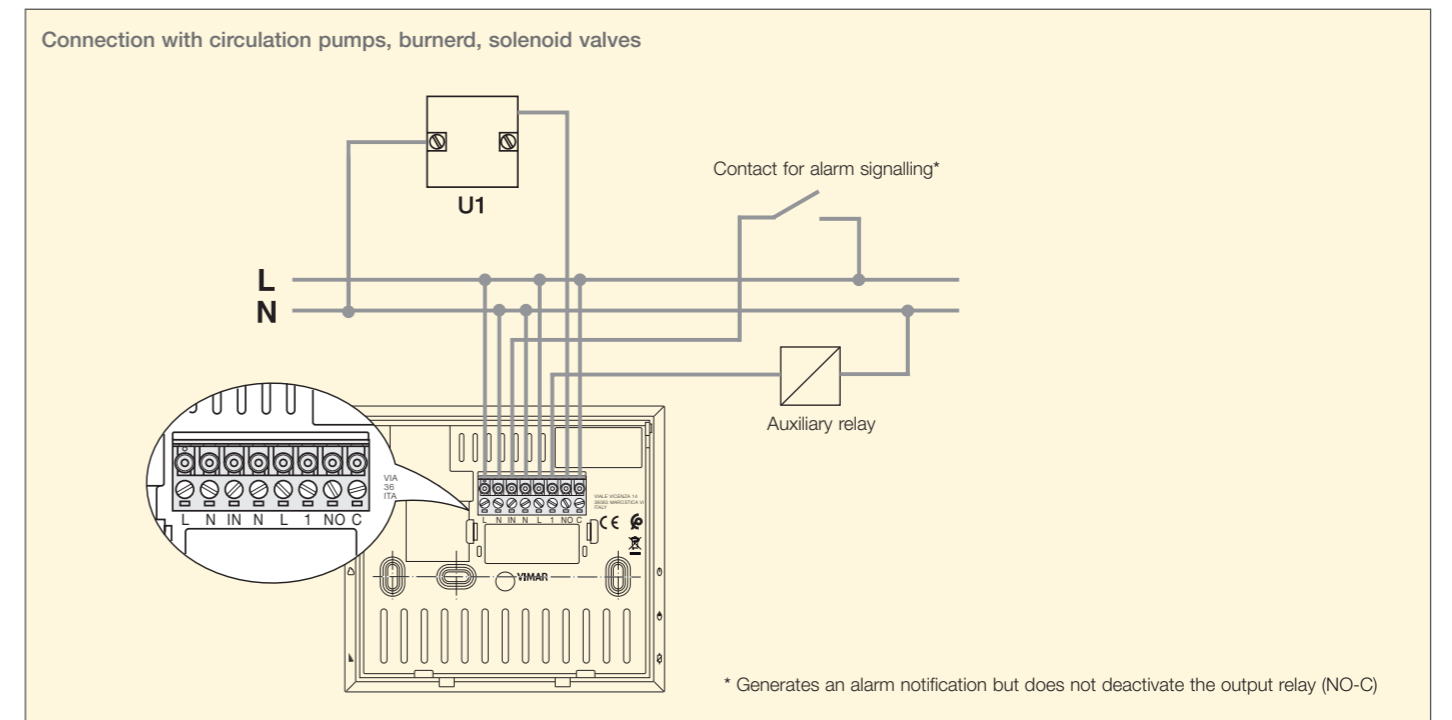

Flush mounting View Wireless thermostats

Connected rotary dial thermostat

The thermostat is fitted with a front dial to adjust the setpoint (between 4°C and 40°C) and a central display with white LED backlit which shows, using the dial, the measured temperature setpoint. The rotary dial is marked by a RGB backlit circular ring, which displays all the thermostat status. In addition, 4 front buttons for: on/off, °C/°F units, display brightness and heating/cooling mode.

The thermostat can be configured in the Bluetooth® wireless technology system using the View Wireless app and, using the gateway 20597-19597-16497-14597 for 02973... and 0K14597.01 for 09473..., it can liaise with the View App and with the Amazon Alexa, Google Assistant and Siri voice assistants.

By means the View app, it is possible switching ON/OFF the thermostat, mode changing, daily and weekly programming and temperature setpoint selecting.

Technical specifications

- rated supply voltage: 100-240 V~, 50/60 Hz;
- dissipated power: 0.55 W;
- RF transmission power: < 100mW (20 dBm);
- frequency range: 2400-2483.5 MHz;
- terminals:
 - 2 terminals (L and N) for line and neutral;
 - 2 terminals for external temperature probe (art. 02965.1 and 20432-19432-14432 for 02973... and art. 02965.1 for 09473...).
- Maximum length of the external sensor connection cable: 10 m. Use a twisted cable with a minimum cross-section of 0.5 mm² (art. 01840);
- 2 C-NO relay terminals;
- relay output with voltage-free contact: 5(2) A 240 V~;
- current settable setpoint: 4°C - 40°C;
- temp. measurement precision (integrated probe): 0.5°C between +15°C and 30°C, 0.8°C at the extremes;
- for use for Heating/Air Conditioning (winter/summer);
- operating modes: Automatic, Manual, Reduction, Absence, Protection, Off, Timed Manual;
- temperature control algorithms: configurable PID or ON/OFF;
- 4 front buttons for control and configuration/reset;
- RGB LED for configuration status (flashing blue) and output status (configurable colour) signalling;
- operating temperature: T40 (0 °C +40 °C) (indoor use);
- protection degree: IP30;
- ErP classification (EU Reg. 811/2013): - ON/OFF: class I, contribution 1%. - PID: class IV, contribution 2%;
- device in class II;
- Configuration via View Wireless app for Bluetooth® wireless technology system.
- Controllable via app View, Alexa, Google, and Siri voice assistants.

Operation

By means the rotary dial and 4 front buttons it is possible:

- heating/cooling set (winter/summer);
- change brightness;
- change the scale of the degrees;
- set the temperature in manual operation.

The circular ring, by means the LEDs, shows:

- LED off: device/ system OFF;
- LED on: heating/cooling system ON;
- lower left LED on: the device in ON but heating/cooling system is OFF because the temperature setpoint is reached.

Reset procedure

To perform the reset and return the device to its factory settings, during the first 5 minutes that the device is powered, press the °C/°F button for 30 s. During these 30 s the circular ring flashes blue and then emits 2 white flashes to confirm the operation.

Conformity to Standard

RED directive, RoHS directive, ErP directive, EN 60730-2-7, EN 60730-2-9, EN 301 489-17, EN 300 328, EN 62479, EN 63000 standards.

Vimar SpA declares that the radio equipment complies with Directive 2014/53/EU. The full text of the EU declaration of conformity is on the product sheet available on the following website: www.vimar.com

Temperature control device regulation (EU) no. 811/2013. REACH (EU) Regulation no. 1907/2006 – Art. 33. The product may contain traces of lead.

Apple HomeKit is a trademark of apple Inc. App Store is a service mark of Apple Inc. To control this HomeKit-enabled accessory, iOS 9.0 or later is recommended. Controlling this HomeKit-enabled accessory automatically and away from home requires an apple TV with tvOS 10.0 or later or an iPad with iOS 10.0 or later or a HomePod/Siri set up as a home hub. The Apple logo, iPhone, and iPad are trademarks of Apple Inc., registered in the U.S. and other countries and regions. App Store is a service mark of Apple Inc. Google, Google Play and Google Home are trademarks of Google LLC. Amazon, Alexa and all related logos are trademarks of Amazon.com, Inc. or its affiliates.



View app



View Wireless app

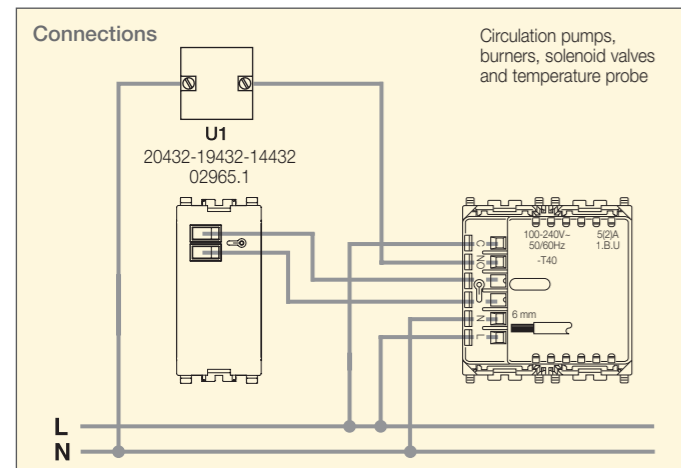
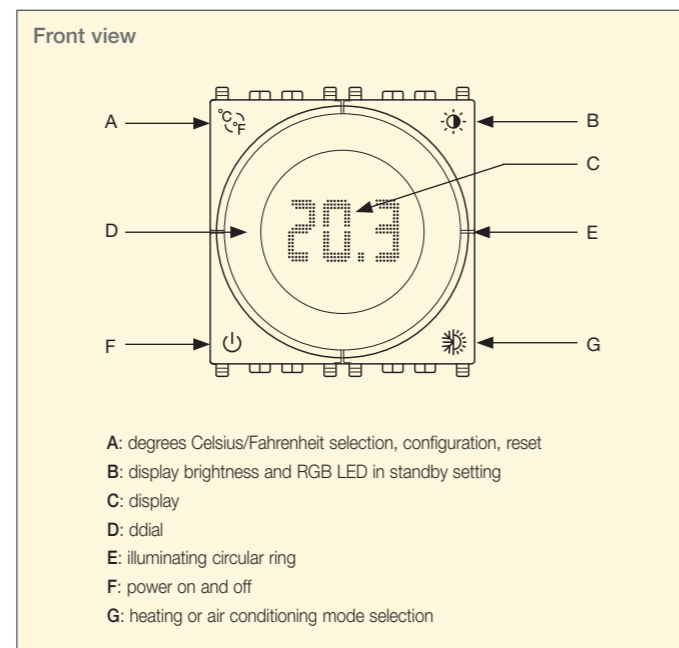

Flush mounting View Wireless thermostats

Connected rotary dial thermostat

Rotary dial thermostat with relay output 5(2) A 240 V~, IoT technology on Bluetooth technology 5.0 standard for the creation of View Wireless mesh system, 1 input for external temperature sensor, 100-240 V~ 50/60 Hz power supply, heating and air conditioning in ON/OFF and PID mode, class I temperature control device (contribution 1%) in ON/OFF mode, class IV (contribution 2%) in PID mode, white LED backlighting with brightness control, 100-240 V 50/60 Hz power supply - 2 modules. To be completed with **Eikon**, **Arké** and **Plana** cover plates, for **Idea** with dedicated mounting frame 16723

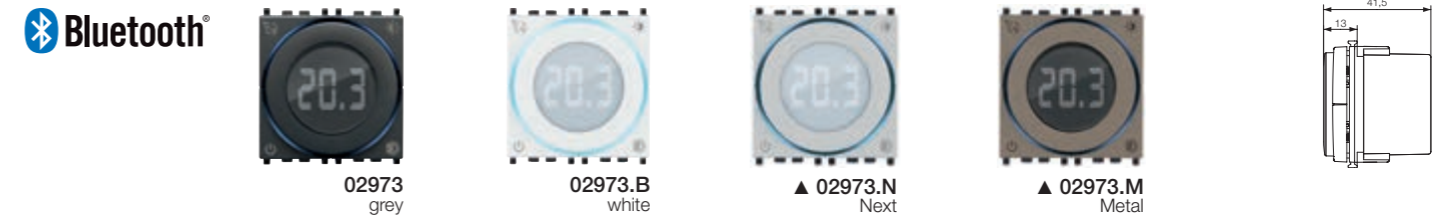

Example of installed thermostat



Connected rotary dial thermostat

Rotary dial thermostat for ambient temperature control, 5(2) A 240 V~ relay output, View Wireless technology on Bluetooth® wireless technology 5.0 for mesh View Wireless system realization, 1 input for outer temperature sensor, supply voltage 100-240 V~ 50/60 Hz, heating and air-conditioning ON/OFF and PID, class I temperature control device (contribution 1%) in ON/OFF mode, class IV (contribution 2%) in PID mode, white LED backlighting and brightness regulation, supply voltage 100-240 V 50/60 Hz - 2 modules

NEVE UP



Example of installed thermostat



Connected magnetic contact

The device is fitted with a magnetic contact and a wired contact which can be used independently. There is a button on the front for configuration and a two-tone red/blue LED for signalling the various statuses. The device can be configured in the Bluetooth® wireless technology system using the View Wireless App and, using gateway 20597-19597-16497-14597, it can liaise with the View App to notify the opening or closing of one of the 2 contacts. It can be associated with thermostat 02973 to switch off the system if a window is open. It is also designed to recall scenarios created with the View app.

Technical specifications

- rated supply voltage: 1,5 V (AA (LR6) battery not supplied);
- Battery life: 3 years
Caution: If the system is switched off (for instance in seasonal use), the batteries will wear out sooner because the contact will continue to search for the powered devices. It is therefore advisable, where possible, to remove the batteries;
- RF transmission power: < 100 mW (20dBm);
- frequency range: 2400-2483.5 MHz;
- terminals:
 - 2 terminals for wired contact;
 - 1 not used;
- magnetic contact to be combined with the magnet supplied;
- the wired contact should be used for connections without potential;
- wired contact installation distance: max 30 m;
- 1 front configuration button;
- 1 two-tone LED for configuration status (flashing blue) and output status signalling;
- operating temperature: 0 °C ÷ +40°C (indoor use);
- configuration via View Wireless app for Bluetooth® wireless technology system.

Conformity to Standard

RED directive, RoHS directive, EN 62368-1, EN 55032, EN 55035, EN 301 489-17, EN 300 328, EN 62479, EN 63000 standards. Vimar SpA declares that the radio equipment complies with Directive 2014/53/EU. The full text of the EU declaration of conformity is on the product sheet available on the following website: www.vimar.com. REACH (EU) Regulation no. 1907/2006 – Art. 33. The product may contain traces of lead.

Apple HomeKit is a trademark of apple Inc. App Store is a service mark of Apple Inc. To control this HomeKit-enabled accessory, iOS 9.0 or later is recommended. Controlling this HomeKit-enabled accessory automatically and away from home requires an apple TV with tvOS 10.0 or later or an iPad with iOS 10.0 or later or a HomePod/Siri set up as a home hub. The Apple logo, iPhone, and iPad are trademarks of Apple Inc., registered in the U.S. and other countries and regions. App Store is a service mark of Apple Inc. Google, Google Play and Google Home are trademarks of Google LLC. Amazon, Alexa and all related logos are trademarks of Amazon.com, Inc. or its affiliates.

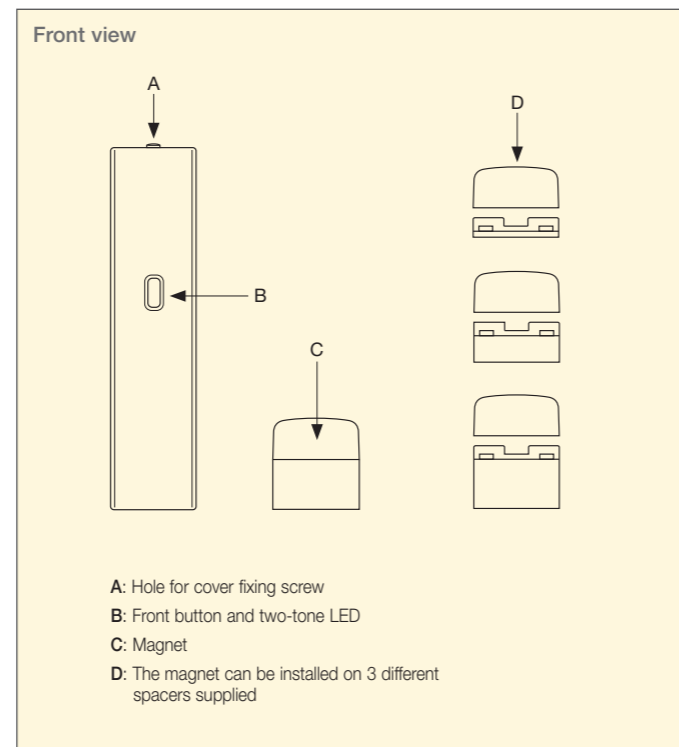

View app



View Wireless app

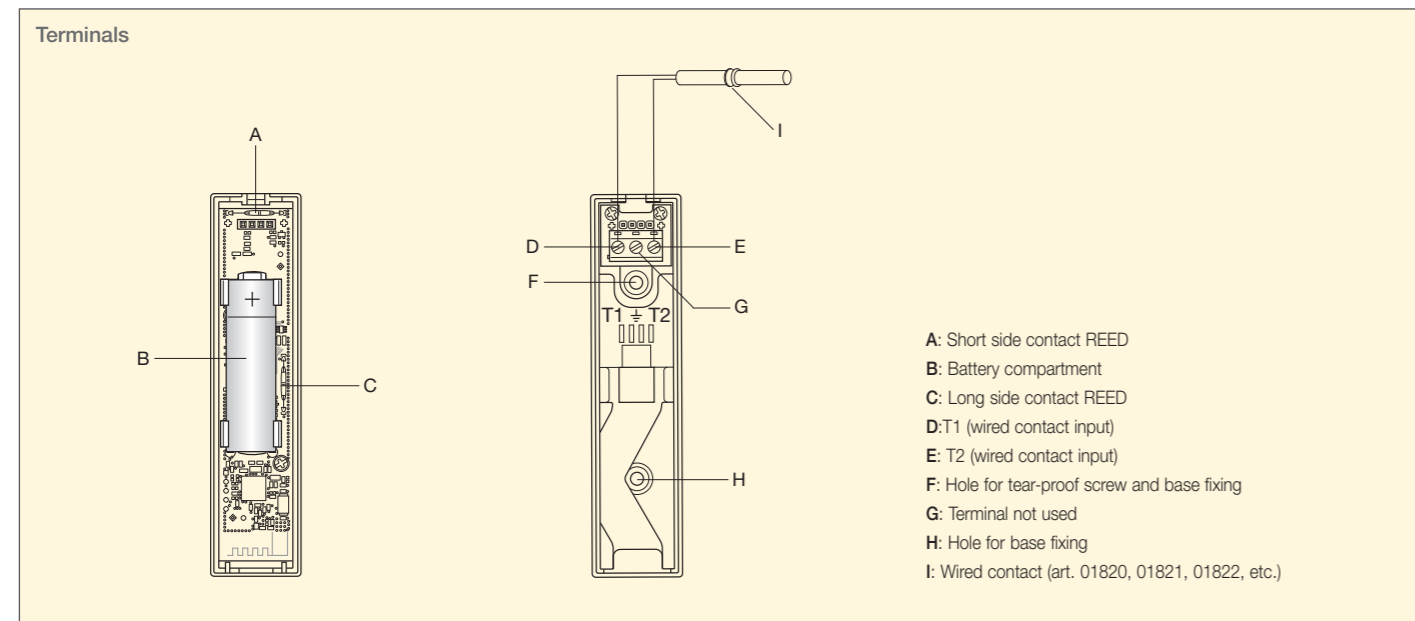

Connected magnetic contact

Connected magnetic contact for windows and doors, View Wireless, Bluetooth 5.0 standard technology for mesh system realization, 1 clean-contact input, powered with AA LR6 1,5 V batteries (not supplied), white. To use as accessory of connected thermostat or with gateway as sensor for notification of magnetic contact open/close

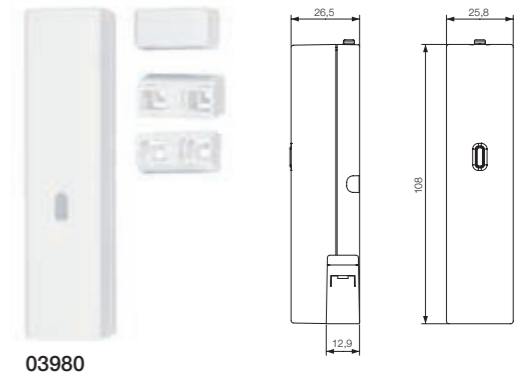

03980

Home automation rotary dial thermostat

The thermostat is fitted with a front dial to adjust the setpoint (between 4°C and 40°C) and a central display with white LED backlight which shows, using the dial, the measured temperature setpoint. The rotary dial is marked by a RGB backlit circular ring, which displays all the thermostat status. In addition, 4 front buttons for: on/off, °C/°F units and many other functions programmable with View Pro app.

The thermostat should be configured in the By-me Plus home automation system with gateway 01410-01411 using the View Pro app and controllable by View app, Alexa and Google Assistant voice assistants.

Technical specifications

- Bus supply voltage: 29 V;
- absorption from the Bus: 30 mA;
- terminals:
 - 2 for TP Bus;
 - 2 for external temperature probe (art. 02965.1 and 20432-19432-14432); Maximum length of the external sensor connection cable: 60 m;
 - 2 for voltage-free contact input (function programmable via the View Pro app). Maximum length of the connection cable on the voltage-free contact input: 30 m;
- For the inputs, use a twisted cable with a minimum cross-section of 0,5 mm² (art. 01840);
- 4 front buttons for control and configuration/reset;
- RGB LED for configuration status (flashing blue) and output status (configurable colour) signalling;
- temperature measurement precision:
 - built-in sensor: measurement range from 0 to 40°, ±0.5 °C between 15 °C and 30 °C, ±0.8 °C at the extremes;
 - auxiliary external sensor: like the built-in sensor. Beyond the operating temperature of the device, the error of the auxiliary external sensor increases up to max 2.5°C @ 80°C;
- hysteresis: adjustable from 0.1°C to 1°C;
- management of 2- and 4-pipe systems;
- heating, air conditioning with management of the neutral zone (only with 4 pipes);
- operation via a dedicated ON/OFF hot/cold valve By-me actuator and proportional type (0-10 V, 4-20 mA) with actuator 01466.1;
- fan coil management (3 speeds/proportional, ON/OFF valves);
- PID or ON/OFF control algorithm;
- boost function: control of an auxiliary actuator to speed up the heating or air conditioning of the environment;

- mild season function: available from the supervisor only for systems configured with 4 pipes, when active, it exchanges the 2 main and secondary outputs (and the related parameters too);
- input for external sensor (art. 02965.1-20432-19432-14432);
- open window management function with delayed power on and off management;
- device can be interfaced natively with third-party systems (KNX systems);
- operating temperature: 0 °C +40°C (indoor use);
- ErP classification (EU Reg. 811/2013): - ON/OFF: class I, contribution 1%. - PID: class IV, contribution 2%;
- the device should be configured with the home automation system gateway 01410-01411 and the View Pro app;
- controllable via View app, Amazon Alexa and Google Assistant voice assistants.

Operation

By means the rotary dial and 4 front buttons, it is possible to adjust and display the ON/OFF operating of the thermostat, the system status (it is working or not) and customise a function (for example heating/cooling).

The rotary dial, by means the backlit LEDs, shows:

- LED off: device/ system OFF;
- LED on: heating/cooling system ON;
- lower left LED on: the device in ON but heating/cooling system is OFF because the temperature setpoint is reached.

Conformity to Standard

BT directive, EMC directive, RoHS directive, EN 60669-2-5, EN 50491, EN IEC 63000 standards.
Temperature control device regulation (EU) no. 811/2013.
REACH (EU) Regulation no. 1907/2006 – Art. 33. The product may contain traces of lead.



View app



View Pro app

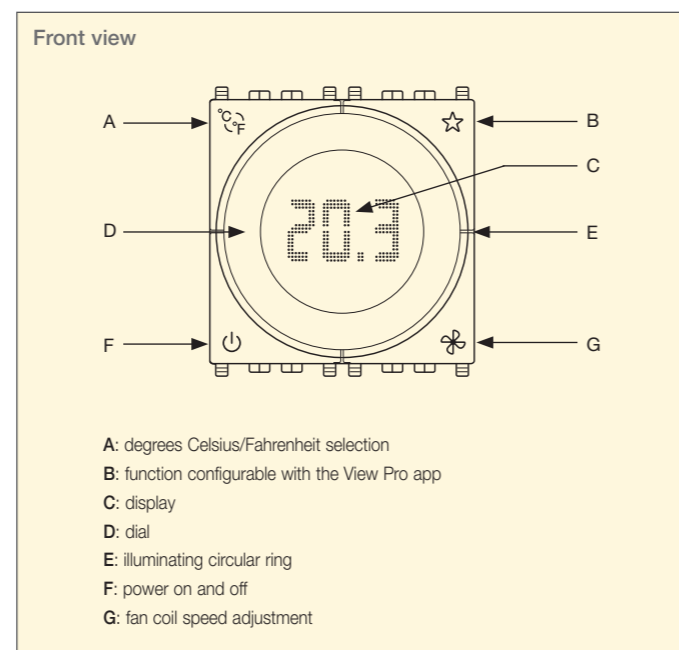

Connections

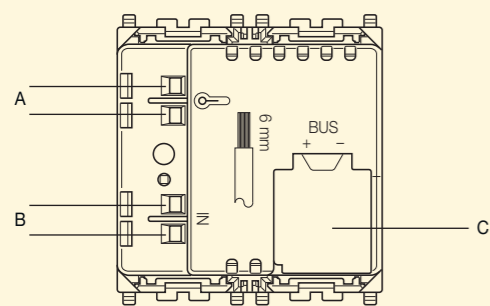

- A: terminals for external temperature sensor
- B: voltage-free contact input with configurable function
- C: By-me Bus terminals

Home automation rotary dial thermostat

Home automation rotary dial thermostat for room temperature control (heating and air conditioning), 2- and 4-pipe system management, 3-speed and proportional fan coil control, class I temperature control device (contribution 1%) in ON/OFF mode, class IV (contribution 2%) in PID mode, can be interfaced with actuator with proportional analogue outputs 01466.1 to make a class V modulating room thermostat (contribution 3%), 1 input for electronic temperature sensor 20432, 19432 or 14432 or wired temperature sensor 02965.1, white LED backlighting - 2 modules. To be completed with **Eikon**, **Arké** and **Plana** cover plates, for **Idea** with dedicated mounting frame 16723

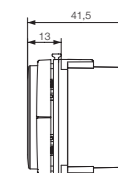
02971
grey02971.B
white▲ 02971.N
Next▲ 02971.M
Metal

Example of installed thermostat



Eikon Exé



Arké Classic



Plana

Idea
(with dedicated mounting frame)

Home automation touch thermostat

The thermostat is integrated with the By-me home automation system for temperature control in 2- or 4-pipe systems (heating/air conditioning) and neutral zone (4-pipe systems only), with "boost" function to activate a second source that makes it possible to reach the desired thermal comfort faster. The thermostat has an RGB back-lit display with 4 keys to control the temperature set point, to turn the temperature control system on/off and, depending on the type of device (.F or .S or .H) for the specific function that identifies it:

- .F: with 3-speed and proportional FAN COIL control;
- .S: with STAR control to recall a configurable scenario;
- .H: with MAKE UP ROOM and DO NOT DISTURB control.

Technical specifications

- rated supply voltage: 29 V Bus;
- absorption: 50 mA;
- terminals:
 - 2 terminals (+ and -) for the Bus;
 - 2 terminals for external temperature probe (art. 02965.1 and 20432-19432-14432). Maximum length of the external sensor connection cable: 60 m;
 - 2 for voltage-free contact input (function programmable via the View Pro app). Maximum length of the connection cable on the voltage-free contact input: 30 m;
- for the inputs, use a twisted cable with a minimum cross-section of 0,5 mm² (art. 01840);
- hysteresis: adjustable from 0.1°C to 1°C;
- temperature measurement precision:
 - built-in sensor: measurement range from 0 to 40°, ±0.5 °C between 15 °C and 30 °C, ±0.8 °C at the extremes;
 - auxiliary external sensor: like the built-in sensor. Beyond the operating temperature of the device, the error of the auxiliary external sensor increases up to max 2.5°C @ 80°C;
- management of 2- and 4-pipe systems;
- heating, air conditioning with management of the neutral zone (only with 4 pipes);
- operation via a dedicated ON/OFF hot/cold valve By-me actuator and proportional type (0-10 V, 4-20 mA) with actuator 01466.1;
- fan coil management (3 speeds/proportional, ON/OFF valves);
- selectable PID or ON/OFF control algorithm;
- boost function: control of an auxiliary actuator to speed up the heating or air conditioning of the environment;
- Mild season function: available from the supervisor only for systems configured with 4 pipes, when active, it exchanges the 2 main and secondary outputs (and the related parameters too);

- input for external sensor (art. 02965.1-20432-19432-14432);
- open window management function with delayed power on and off management;
- device can be interfaced natively with third-party systems (KNX systems);
- relative humidity display when associated with the related sensor (only for art. .F and .S);
- settable RGB back-lit display;
- operating temperature: 0°C - +40°C (indoor use);
- ErP classification (EU Reg. 811/2013):
 - ON/OFF: class I, contribution 1%;
 - PID: class IV, contribution 2%;
 - with actuator with proportional analogue outputs 01466.1: class V, contribution 3%;
- configurable with the View Pro app;
- controllable via View app, Amazon Alexa and Google Assistant voice assistants.

Conformity to Standard

BT directive, EMC directive, RoHS directive, EN 60669-2-5, EN 50491, EN IEC 63000 standards. Temperature control device regulation (EU) no. 811/2013. REACH (EU) Regulation no. 1907/2006 – Art. 33. The product may contain traces of lead.

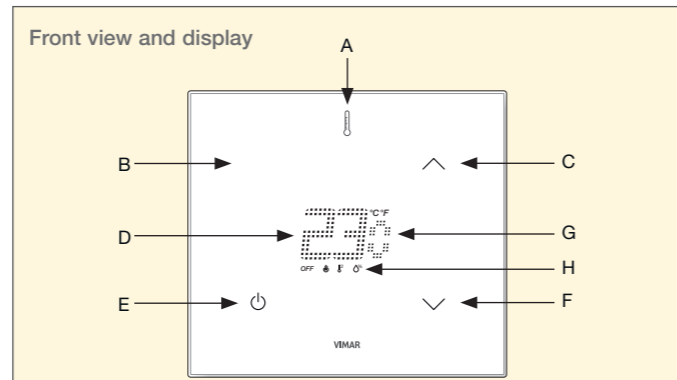

A	Brightness sensor	
B	for 21514.F	Fan coil speed control (0-1-2-3 or Proportional/Automatic)
	for 21514.S	Push button/scenario activation (configurable)
	for 21514.H	MAKE UP ROOM or DO NOT DISTURB message
C	Temperature set point increase (0.5° C or 1 °F steps)	
D	Display	
E	Power ON/OFF	
F	Temperature set point decrease (0.5° C or 1 °F steps)	
G	Temperature measured	
H	Output active in heating/air conditioning	
	for 21514.F and 21514.S	Relative humidity
	for 21514.F and 21514.S	Temperature measured by external probe
	for 21514.H	Make up room request
	for 21514.H	Do not disturb request
OFF with LED on	Thermostat off	

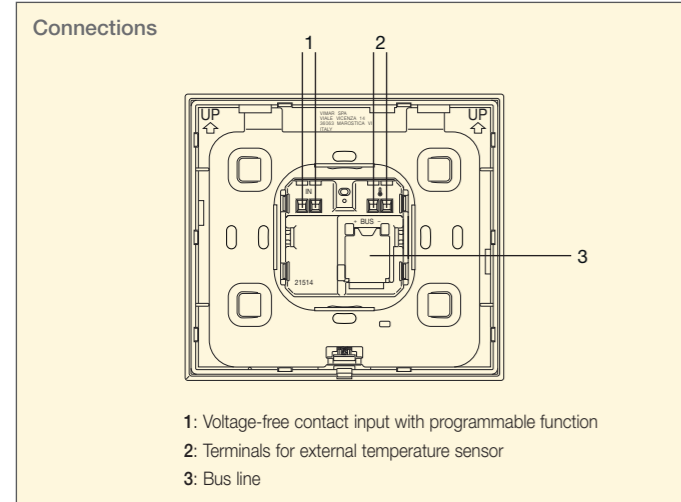

Home automation touch thermostat - FAN COIL

Touch screen home automation thermostat for room temperature control (heating and air conditioning), 3-speed and proportional FAN COIL control, class I temperature control device (contribution 1%) in ON/OFF mode, class IV (contribution 2%) in PID mode, can be interfaced with actuator with proportional analogue outputs 01466.1 to make a class V modulating room thermostat (contribution 3%), 1 input for electronic temperature sensor 20432, 19432 or 14432 or wired temperature sensor 02965.1, 1 programmable digital input, RGB LED backlighting - 2 modules



21514.F.70 white diamond



21514.F.76 black diamond

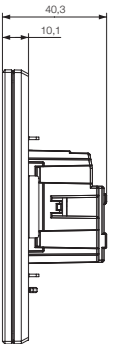

Home automation touch thermostat - STAR

Touch screen home automation thermostat for room temperature control (heating and air conditioning), configurable STAR control, class I temperature control device (contribution 1%) in ON/OFF mode, class IV (contribution 2%) in PID mode, can be interfaced with actuator with proportional analogue outputs 01466.1 to make a class V modulating room thermostat (contribution 3%), 1 input for electronic temperature sensor 20432, 19432 or 14432 or wired temperature sensor 02965.1, 1 programmable digital input, RGB LED backlighting - 2 modules



21514.S.70 white diamond



21514.S.76 black diamond

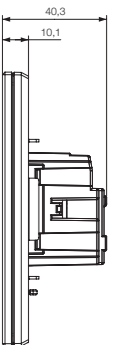

Home automation touch thermostat - MAKE UP ROOM and DO NOT DISTURB

Touch screen home automation thermostat for room temperature control (heating and air conditioning), MAKE UP ROOM and DO NOT DISTURB control, class I temperature control device (contribution 1%) in ON/OFF mode, class IV (contribution 2%) in PID mode, can be interfaced with actuator with proportional analogue outputs 01466.1 to make a class V modulating room thermostat (contribution 3%), 1 input for electronic temperature sensor 20432, 19432 or 14432 or wired temperature sensor 02965.1, 1 programmable digital input, RGB LED backlighting - 2 modules



21514.H.70 white diamond



21514.H.76 black diamond

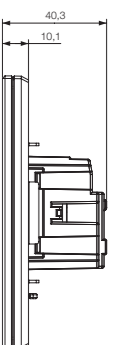

Building automation rotary dial thermostat

The thermostat is fitted with a front dial to adjust the setpoint (between 4°C and 40°C) and a central display with white LED backlit which shows, using the dial, the measured temperature setpoint. The rotary dial is marked by a RGB backlit circular ring, which displays all the thermostat status. In addition, 4 front buttons for: on/off, °C/°F units and many other functions. Configuration of the thermostat, physical address, parameters and its operation, etc. occurs using the ETS software.

Technical specifications

- Bus supply voltage: 29 V;
- absorption from the Bus: 30 mA;
- terminals:
 - 2 for KNX Bus;
 - 2 for external temperature probe (art. 02965.1 and 20432-19432-14432); Maximum length of the external sensor connection cable: 60 m;
 - 2 for voltage-free contact input. Maximum length of the connection cable on the voltage-free contact input: 30 m;
- For the inputs, use a twisted cable with a minimum cross-section of 0,5 mm² (art. 01820);
- 4 front buttons for control and configuration/reset;
- RGB LED for configuration status (flashing blue) and output status (configurable colour) signalling;
- temperature measurement precision:
 - built-in sensor: measurement range from 0 to 40°, ±0.5 °C between 15 °C and 30 °C, ±0.8 °C at the extremes;
 - auxiliary external sensor: like the built-in sensor. Beyond the operating temperature of the device, the error of the auxiliary external sensor increases up to max 2.5°C @ 80°C;
- hysteresis: adjustable from 0.1°C to 1°C;
- management of 2- and 4-pipe systems;
- heating, air conditioning with management of the neutral zone (only with 4 pipes);
- operation via a dedicated ON/OFF hot/cold valve actuator or proportional type (0-10 V, 4-20 mA);
- fan coil management (3 speeds/proportional, ON/OFF valves);
- PI or ON/OFF control algorithm;

- boost function: control of an auxiliary actuator to speed up the heating or air conditioning of the environment;
- mild season function: available only for systems configured with 4 pipes, when active, it exchanges the 2 main and secondary outputs (and the related parameters too);
- open window management function with delayed power on and off management;
- operating temperature: 0 °C +40°C (indoor use);
- ErP classification (EU Reg. 811/2013): - ON/OFF: class I, contribution 1%. - PI: class IV, contribution 2%.

Operation

By means the rotary dial and 4 front buttons, it is possible to adjust and display the ON/OFF operating of the thermostat, the system status (it is working or not) and customise a function (for example heating/cooling).

The rotary dial, by means the backlit LEDs, shows:

- LED off: device/ system OFF;
- LED on: heating/cooling system ON;
- lower left LED on: the device in ON but heating/cooling system is OFF because the temperature setpoint is reached.

Conformity to Standard

BT directive, EMC directive, RoHS directive, EN 60669-2-5, EN 50491, EN IEC 63000 standards.

Temperature control device regulation (EU) no. 811/2013. REACH (EU) Regulation no. 1907/2006 – Art. 33. The product may contain traces of lead.



By-web app

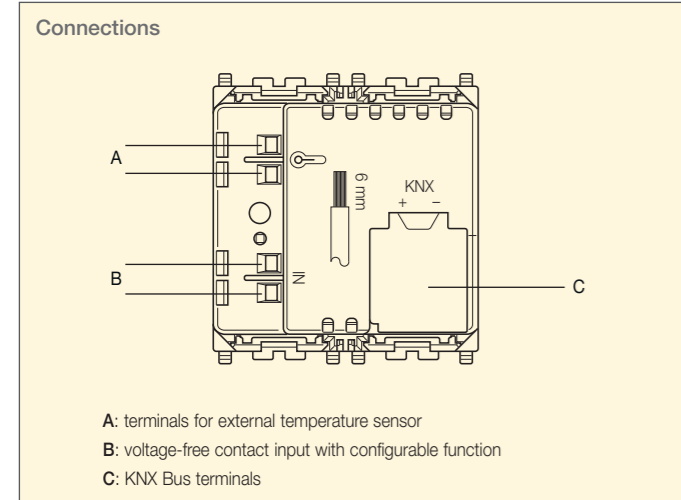
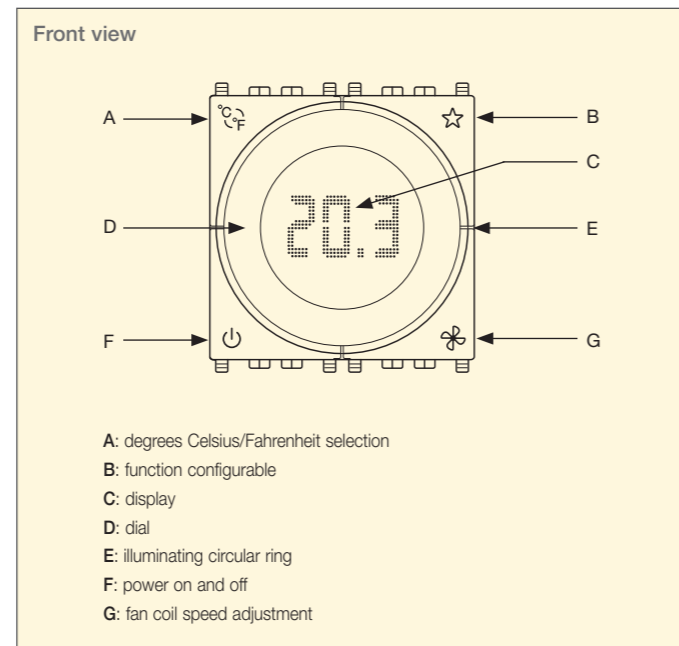

Building automation rotary dial thermostat

Rotary dial thermostat for room temperature control (heating and air conditioning), KNX standard building automation system, class I temperature control device (contribution 1%) in ON/OFF mode, class IV (contribution 2%) in PI mode, can be interfaced with actuator with proportional analogue outputs KNX to make a class V modulating room thermostat (contribution 3%), 1 input for electronic temperature sensor 20432, 19432 or 14432 or wired temperature sensor 02965.1, 1 programmable digital input, white LED backlighting - 2 modules. To be completed with **Eikon**, **Arké** and **Plana** cover plates, for **Idea** with dedicated mounting frame 16723



Example of installed thermostat



Building automation touch thermostat

The thermostat is suitable for controlling room temperature (heating/air-conditioning) in 2 or 4 pipe systems and neutral zone (only in 4-pipe systems), with the “boost” function to activate a second source that makes it possible to reach the desired thermal comfort faster. It can interact with other thermostats and with a monitoring unit (PC with Well-contact Suite software). The thermostat has an RGB back-lit display with 4 keys to control the temperature set point, to turn the temperature control system on/off and, depending on the type of device (.F or .S or .H) for the specific function that identifies it:

- .F:** with 3-speed and proportional FAN COIL control;
- .S:** with STAR control to recall a configurable scenario;
- .H:** with MAKE UP ROOM and DO NOT DISTURB control.

Technical specifications

- rated supply voltage: 29 V Bus;
- absorption: 50 mA;
- terminals:
 - 2 terminals (+ and -) for the KNX Bus;
 - 2 terminals for external temperature probe (art. 02965.1 and 20432-19432-14432). Maximum length of the external sensor connection cable: 60 m;
 - 2 for voltage-free contact input with configurable function. Maximum length of the connection cable on the voltage-free contact input: 30 m.
- For the inputs, use a twisted cable with a minimum cross-section of 0,5 mm² (art. 01890);
- hysteresis: adjustable from 0.1°C to 1°C;
- temperature measurement precision:
 - built-in sensor: measurement range from 0 to 40°, ±0.5 °C between 15 °C and 30 °C, ±0.8 °C at the extremes;
 - auxiliary external sensor: like the built-in sensor. Beyond the operating temperature of the device, the error of the auxiliary external sensor increases up to max 2.5°C @ 80°C;
- management of 2- and 4-pipe systems;
- heating, air conditioning with management of the neutral zone (only with 4 pipes);
- operation via a dedicated ON/OFF and proportional type hot/cold valve actuator (0-10 V, 4-20 mA) with actuator 01466.1;
- fan coil management (3 speeds/proportional, ON/OFF valves);
- selectable PID or ON/OFF control algorithm;
- boost function: control of an auxiliary actuator to speed up the heating or air conditioning of the environment;

- Mild season function: available from the supervisor only for systems configured with 4 pipes, when active, it exchanges the 2 main and secondary outputs (and the related parameters too);
- input for external sensor (art. 02965.1-20432-19432-14432);
- open window management function with delayed power on and off management;
- device can be interfaced natively with third-party systems (KNX systems).
- relative humidity display when associated with the related sensor (only for art. .F and .S);
- settable RGB back-lit display;
- operating temperature: 0°C - +40°C (indoor use);
- ErP classification (EU Reg. 811/2013):
 - ON/OFF: class I, contribution 1%;
 - PID: class IV, contribution 2%;
 - with actuator with proportional analogue outputs 01466.1: class V, contribution 3%.
- configurable via ETS software.

Conformity to Standard

BT directive, EMC directive, RoHS directive, EN 60669-2-5, EN 50491, EN IEC 63000 standards. Temperature control device regulation (EU) no. 811/2013. REACH (EU) Regulation no. 1907/2006 – Art. 33. The product may contain traces of lead.

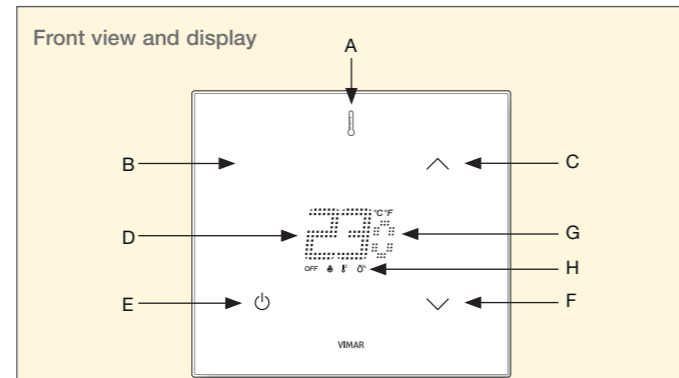
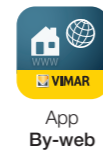

A	Brightness sensor	
B	for 21814.F	Fan coil speed control (0-1-2-3 or Proportional/Automatic)
	for 21814.S	Push button/scenario activation (configurable)
	for 21814.H	MAKE UP ROOM or DO NOT DISTURB message
C	Temperature set point increase (0.5° C or 1 °F steps)	
D	Display	
E	Power ON/OFF	
F	Temperature set point decrease (0.5° C or 1 °F steps)	
G	Temperature measured	
H	Output active in heating/air conditioning	
	for 21814.F and 21814.S	Relative humidity
	for 21814.F and 21814.S	Temperature measured by external probe
	for 21814.H	Make up room request
	per 21814.H	Do not disturb request
OFF with LED on	Thermostat off	

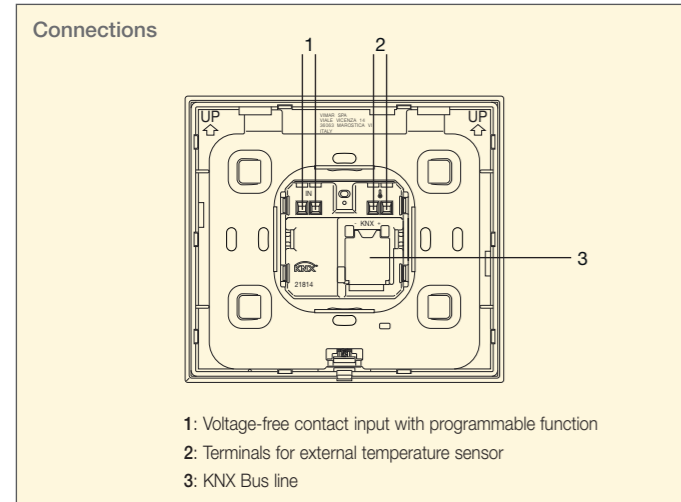

Building automation touch thermostat - FAN COIL

Touch screen thermostat for room temperature control (heating and air conditioning), KNX standard home automation system, 3-speed and proportional FAN COIL control, class I temperature control device (contribution 1%) in ON/OFF mode, class IV (contribution 2%) in PID mode, can be interfaced with actuator with proportional analogue outputs 01466.1 to make a class V modulating room thermostat (contribution 3%), 1 input for electronic temperature sensor 20432, 19432 or 14432 or wired temperature sensor 02965.1, 1 programmable digital input, RGB LED backlighting - 2 modules



21814.F.70 white diamond



21814.F.76 black diamond

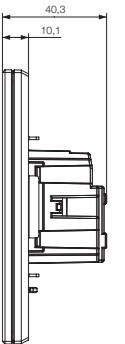

Building automation touch thermostat - STAR

Touch screen thermostat for room temperature control (heating and air conditioning), KNX standard home automation system, configurable STAR control, class I temperature control device (contribution 1%) in ON/OFF mode, class IV (contribution 2%) in PID mode, can be interfaced with actuator with proportional analogue outputs 01466.1 to make a class V modulating room thermostat (contribution 3%), 1 input for electronic temperature sensor 20432, 19432 or 14432 or wired temperature sensor 02965.1, 1 programmable digital input, RGB LED backlighting - 2 modules



21814.S.70 white diamond



21814.S.76 black diamond

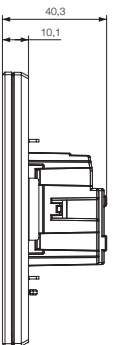

Building automation touch thermostat - MAKE UP ROOM and DO NOT DISTURB

Touch screen thermostat for room temperature control (heating and air conditioning), KNX standard home automation system, MAKE UP ROOM and DO NOT DISTURB control, class I temperature control device (contribution 1%) in ON/OFF mode, class IV (contribution 2%) in PID mode, can be interfaced with actuator with proportional analogue outputs 01466.1 to make a class V modulating room thermostat (contribution 3%), 1 input for electronic temperature sensor 20432, 19432 or 14432 or wired temperature sensor 02965.1, 1 programmable digital input, RGB LED backlighting - 2 modules



21814.H.70 white diamond



21814.H.76 black diamond

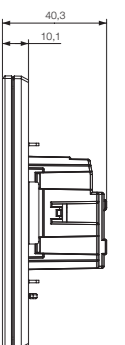

Opportunities for you

We are a team of professionals who provide expert support and customized global solutions for automating, connecting and monitoring the entire building while assuring total aesthetic coordination of all visible devices.

vimar.com - our on-line service platform, available 24/7. Vimar's know-how at your fingertips.

Navigate the on-line catalogue, a detailed database of all our codes with technical drawings, instruction sheets, and product photos.

Go to the **download section** and choose your language:

- **Dedicated catalogues** and **brochures** of our product range, systems and solutions.
- **Video** tutorial section, also available on You Tube channel.

From the homepage go to the **News** to keep yourself updated and to **References** to see our latest **Projects**.



Energia Positiva. Insieme

