

LINEA



Unique line

Experience, tradition, innovation.
More than 75 years of expertise
in shaping energy.

Linea. The design of a perfect Line.

A new series featuring an unprecedented and elegant design, which brings together the understated allure of sophisticated styling with state-of-the-art technology.

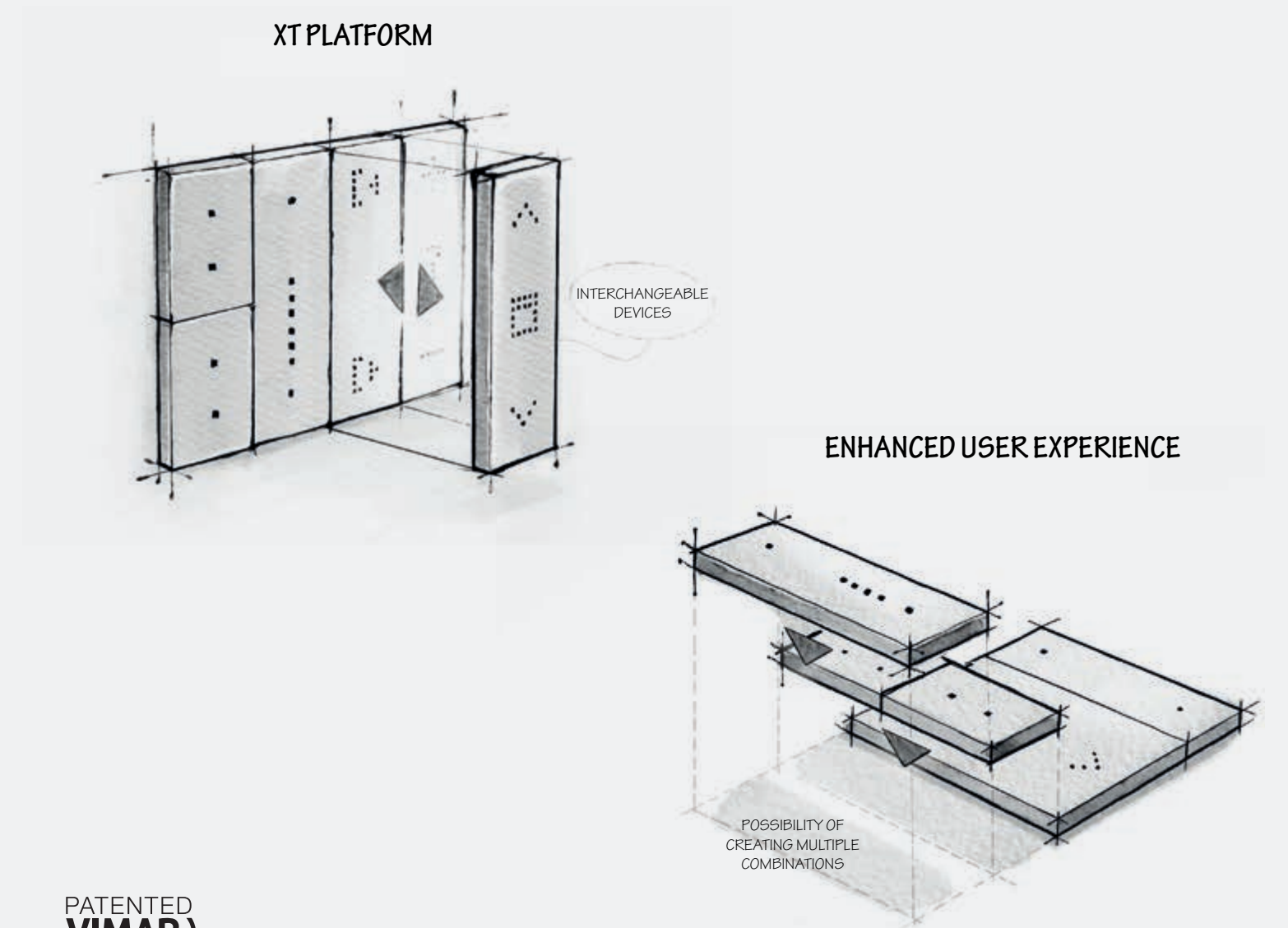
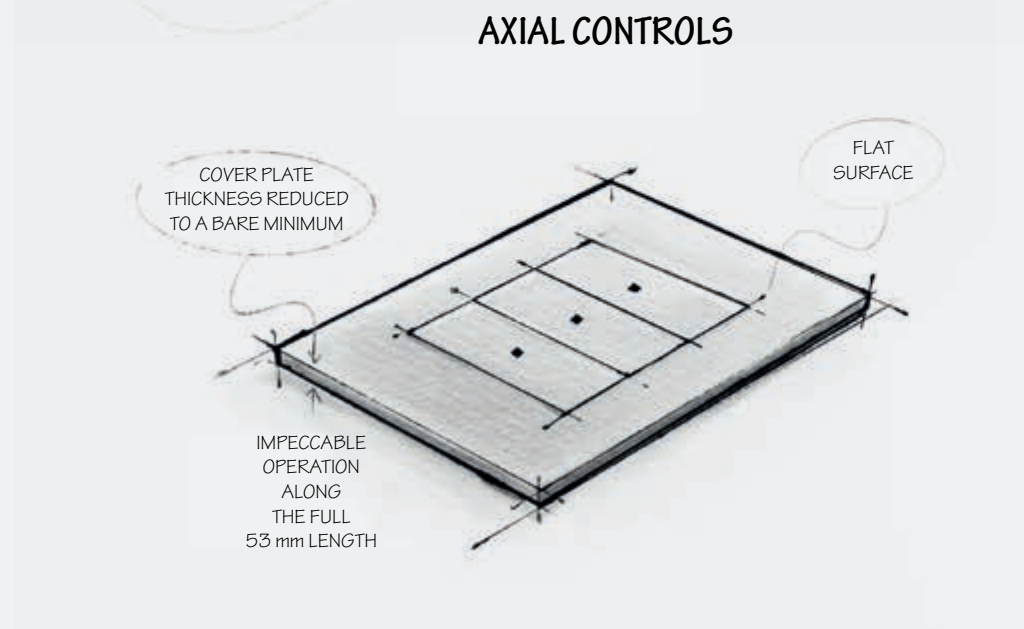
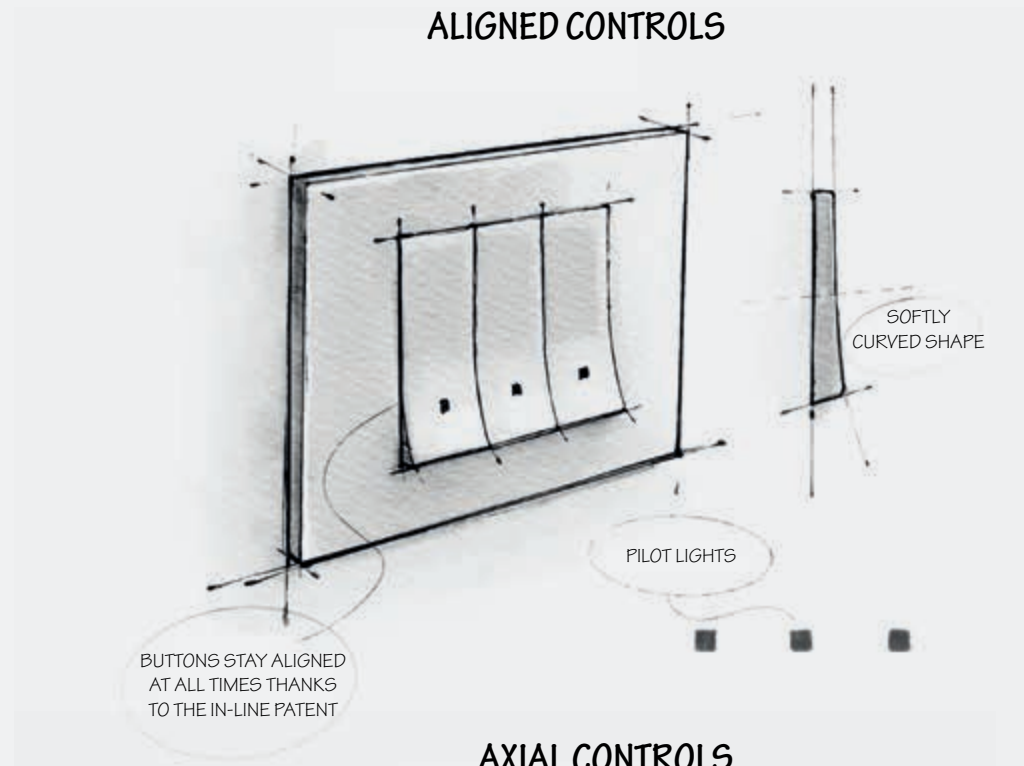

PATENTED
VIMAR

Linea brings together innovation and tradition, thanks also to multiple patents registered to make it truly one of a kind.



-80% 
CO₂ eq. emissions

Essential, intuitive and sustainable.

With Linea, we have redesigned energy. The result is a new design with understated shapes and a distinctive profile that makes it truly unique, also in terms of environmental sustainability, since it reduces CO₂ emissions by 80%.

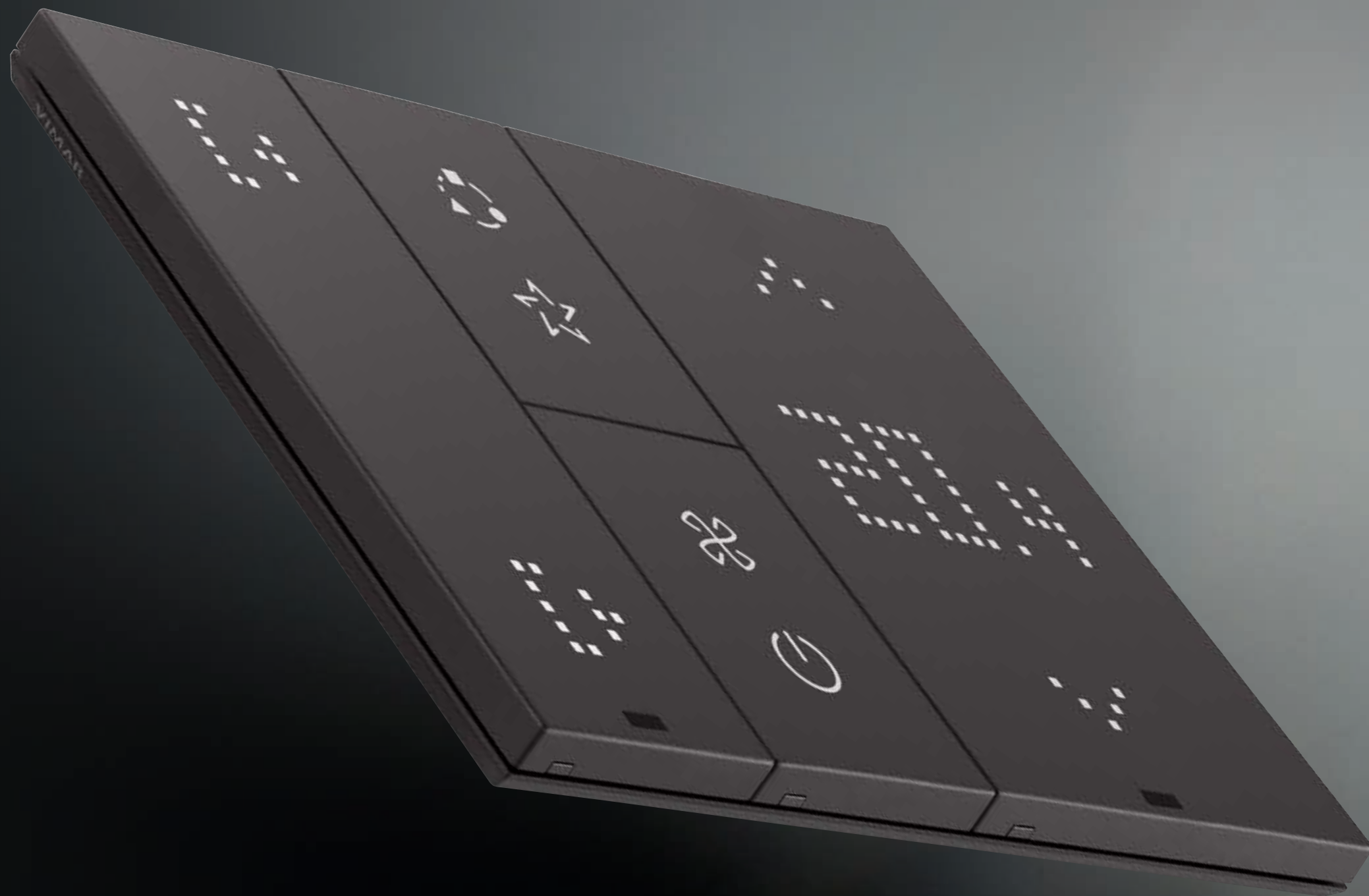

Dynamic.

Linea is also digital, thanks to the innovative XT platform, a high-tech experience for the automated home.

**The research for absolute planarity:
slim thickness and flat surface.**



Accurate and sensitive interaction.

A special finish, devised specifically and achieved using laser processing, makes the surface enjoyable to touch for an enhanced sensory experience.

Sophisticated design.

Painstaking research and in-depth studies into design have given rise to a perfectly flat surface.

A gentle and harmonious Linea.

The unique shape of the aligned control.

Starting with a sophisticated planarity, the gently curved profile of the control creates a light protrusion, making it easy to find with your fingers.



Controls that are always aligned.

Once activated, the control resumes its original position, guaranteeing perfect alignment at all times thanks to our patented In-line technology.

Perfectly flat surface of the axial control.

Large control surface thanks to the increased height of the button and the possibility of pressing any part of the surface. Precise and silent kinematic mechanism.



Slim profile.

New patented reduced-depth controls make Linea extremely slimline. The unprecedented ergonomic shapes make it slender and lightweight, perfect on any wall.

XT platform: an enhanced user experience.

Absolute planarity of controls.

Innovative styling of the home automation system controls, extreme ease of use and ergonomic design across the entire surface.



Sensitive precision and delightful to touch.

Thanks to the special finish of the controls and to the new activation mechanisms, which stand out for their precision, silent operation and impeccable feedback.



Modular and scalable to suit any need.

The devices in the XT platform are scalable in time and extremely easy to use: from a simple control for lights and roller shutters, to temperature management and even the activation of scenarios to a home automation system that is always up-to-date and functional.

**Matching styling.
For everyday elegance
at your fingertips.**

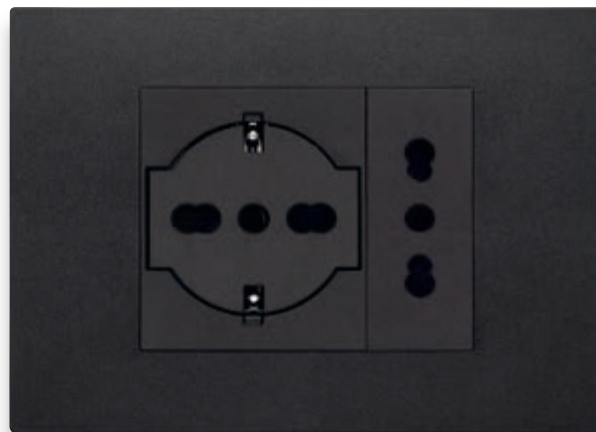
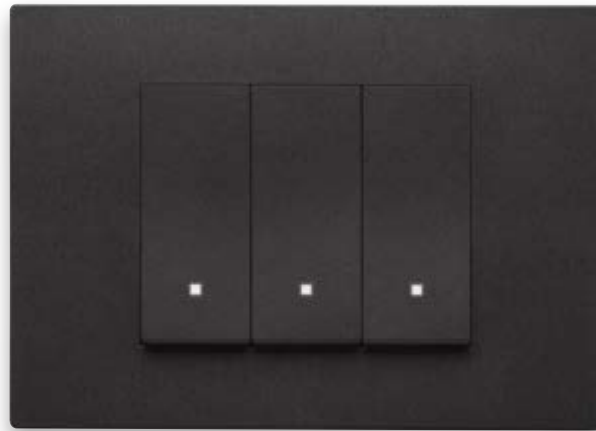

Perfect results in any interior design.

Understated, flat design from the lighting device to the socket outlet, which thus feature perfectly matching styling to blend in seamlessly with any setting.



**Attention to detail, impeccable finish and
state-of-the-art technology.**

Linea with XT platform ensures impeccable matching styling by incorporating all the desired functions into the interior design, for any domestic taste.



Lighting with vertical light beam.

The control with a patented vertical light beam creates a soft glow on the surface of the cover plate: the result is a discrete yet distinctive effect on the wall.

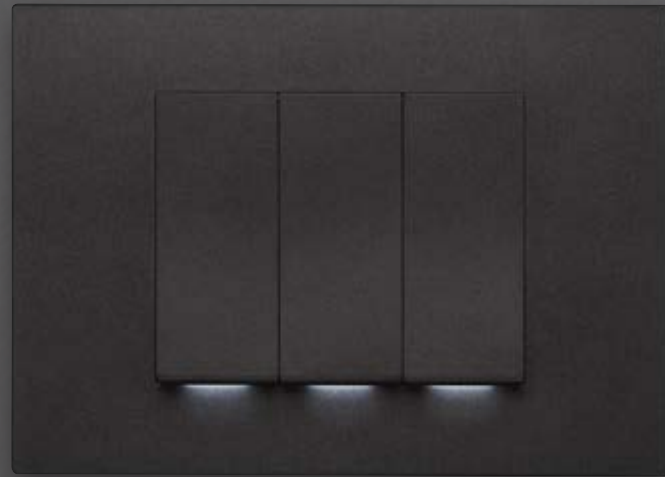

Elegantly curved controls that are always aligned.

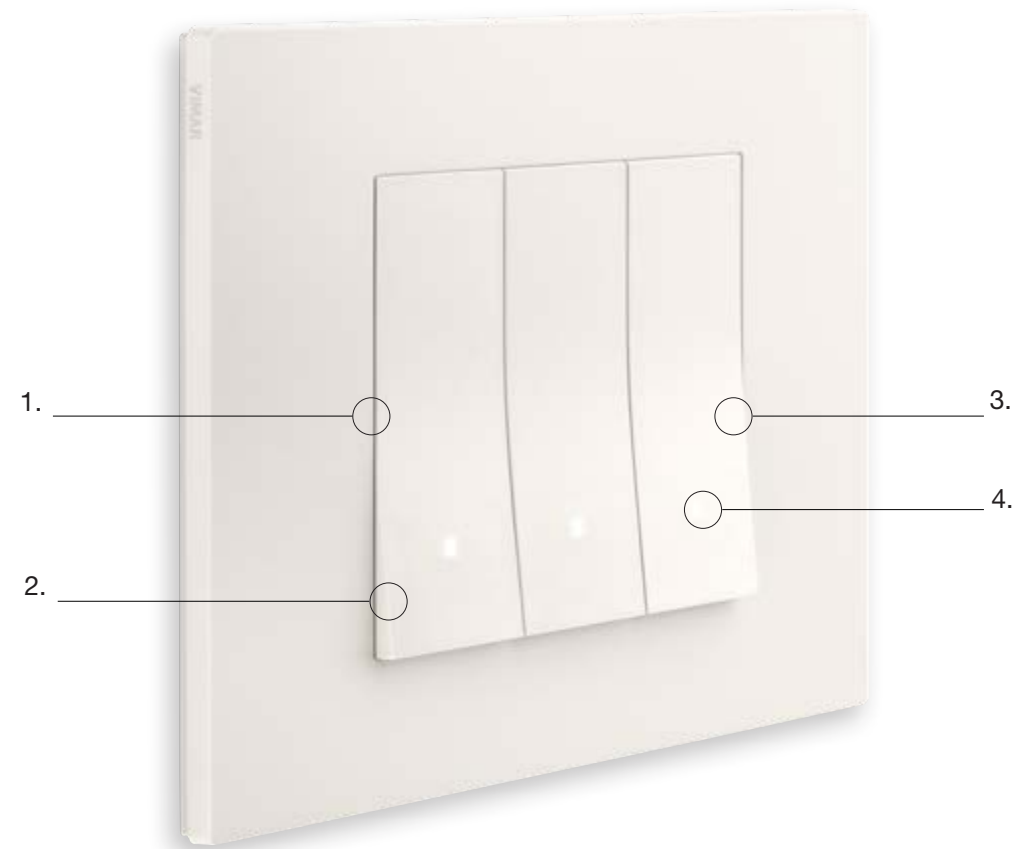

1.

Exclusive shape with a gentle, minimally protruding curvature.

2.

Once activated, the control resumes its original position, guaranteeing perfect alignment at all times thanks to patented In-line technology.

3.

Maximum user-friendliness, thanks to the 53 mm size of the control and its slight protrusion.

4.

Two different lighting possibilities: the stylish square or a vertical beam of light in the dedicated button.



Perfect planarity and precise operation of axial controls.

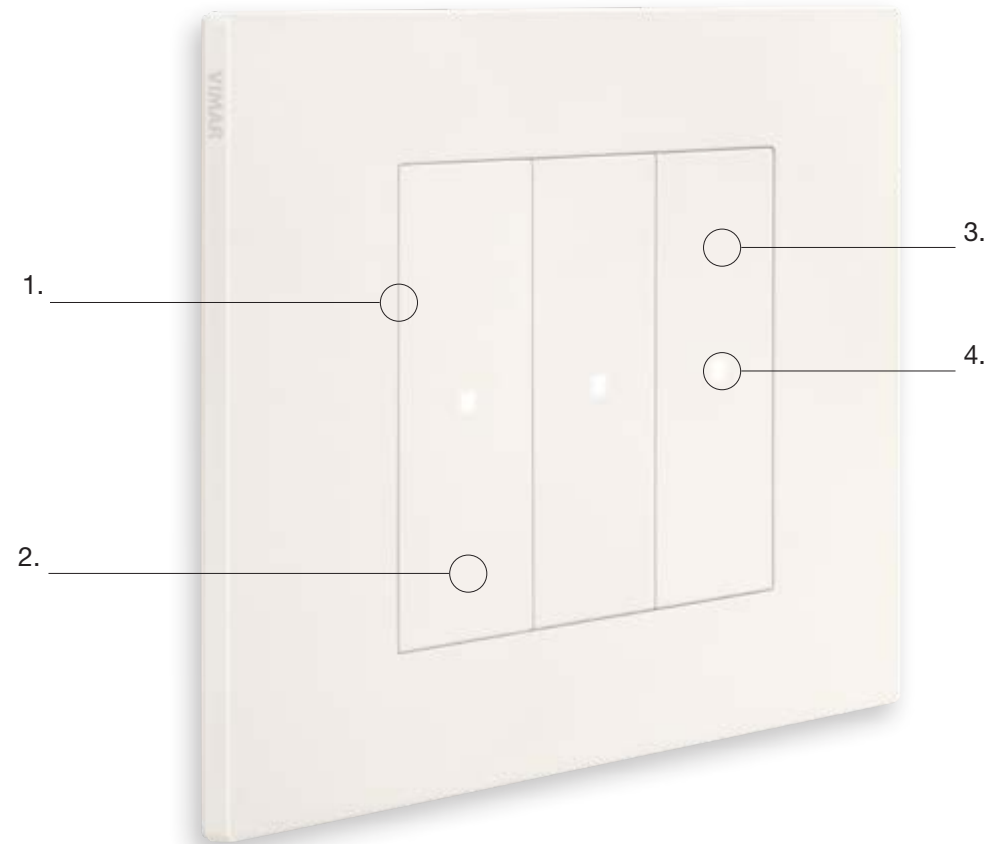

1.

Absolute planarity effect: the control remains perfectly aligned with the surface of the cover plate.

2.

Generously-sized 53 mm button which can be operated across the entire surface.

3.

Control with patented mechanism which stands out for its kinematic precision and requires minimal pressure to be activated.

4.

Sophisticated light details. In the axial control, the distinctive illuminated mark identifies its function in the dark.

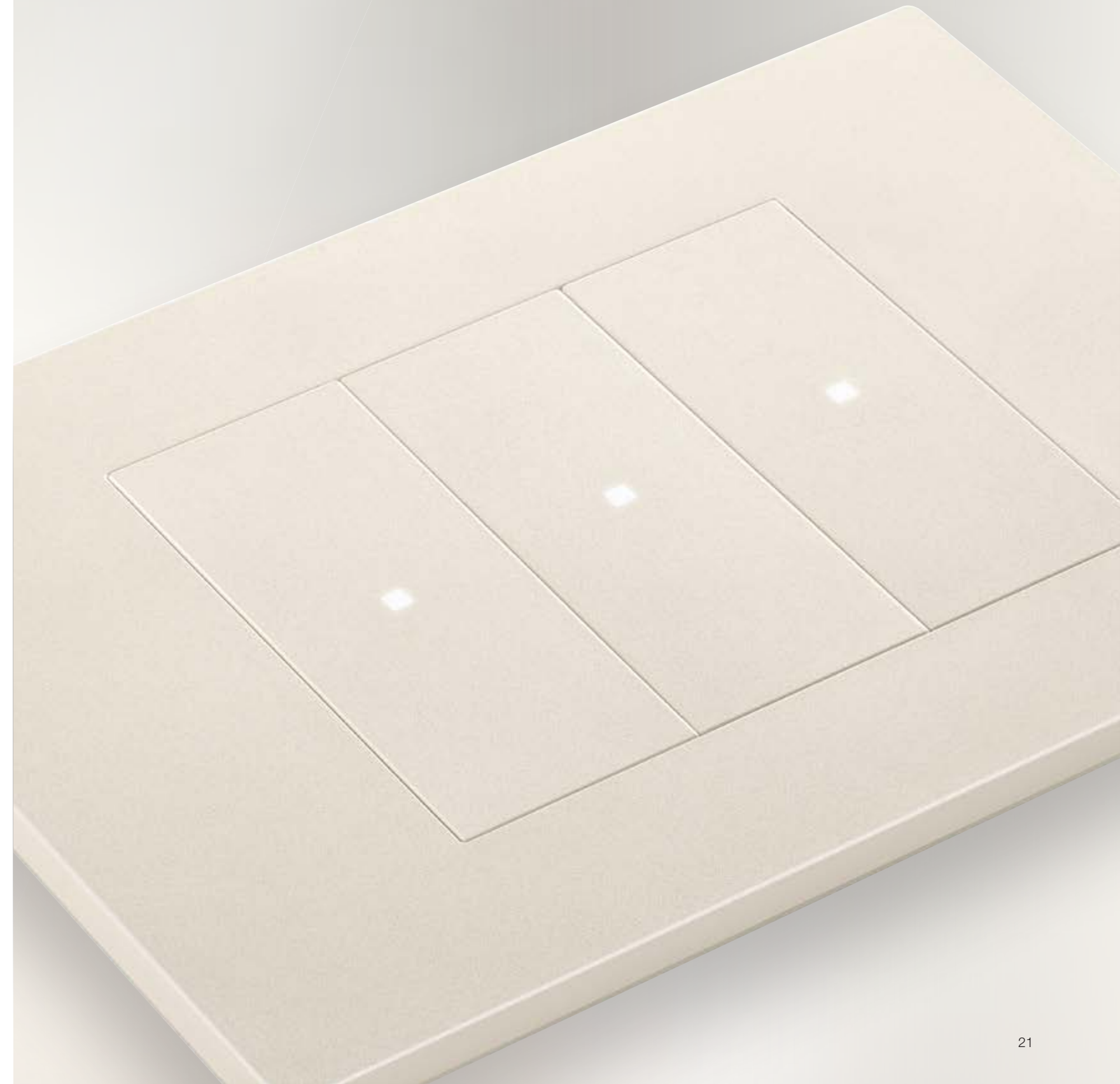

The XT platform: user-friendly, expandable and dynamic.



1.

Innovative styling with controls across the entire surface and activation with micro-switch with flawless feedback; understated, flat design and extremely user-friendly.

2.

Extensive scalability and expandability of controls. You can move the front to other control devices in one simple move, without having to adjust any wiring.

3.

Controls with proximity sensor: they are activated when tapped, providing a gentle confirmation feedback.

4.

Controls with sensitive precision, pleasant to touch, ergonomically designed and activated across the whole surface.



The XT platform, home automation naturally.

The transformation of the home automation system functions is easy and scalable over time in one simple move. Choosing between the different types of available controls with the XT platform, the 1-way switch can easily be composed and configured, ready for any requirement.

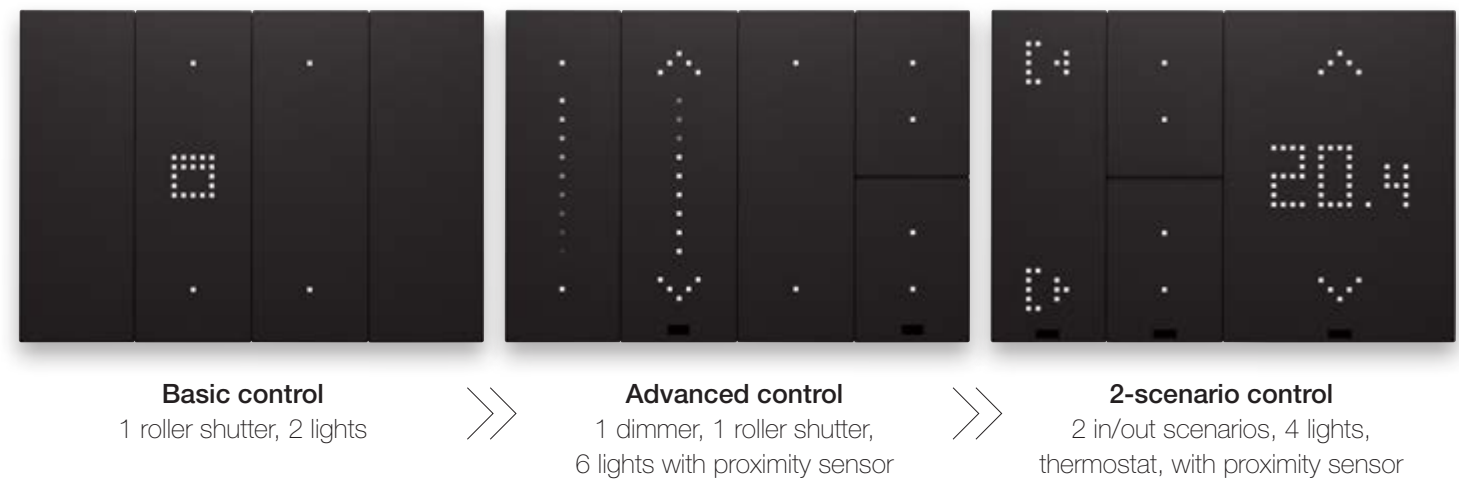
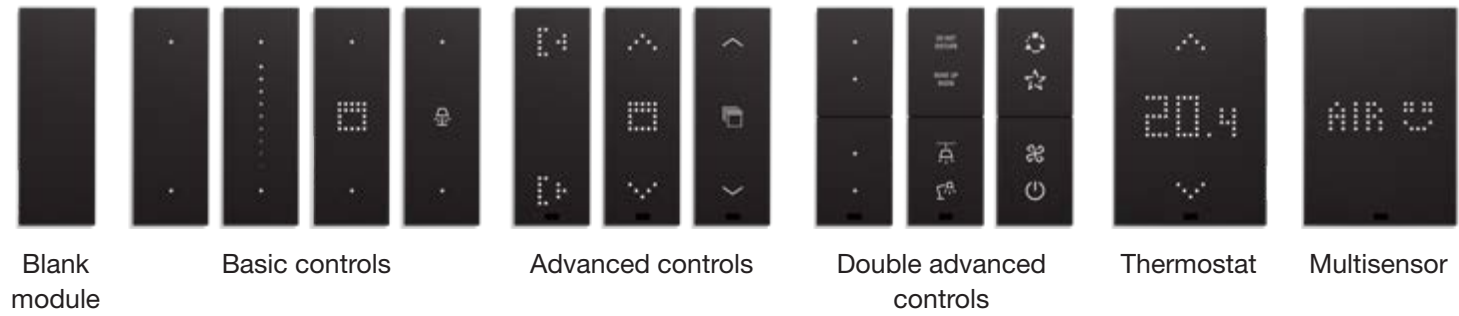

You can move the elements and configure the interfaces to create self-explanatory controls with dynamic LED symbols, making the device extremely user-friendly.

Increasing the functions on the same lighting device is an advantage both during installation as well as for renovations, without the need for any masonry work, thus accommodating all needs in time.

All the home automation functions can be managed using the View App, with which the system can be remote controlled via smartphone/tablet.



Flat, perfectly matching design.

One unique style for all functions.

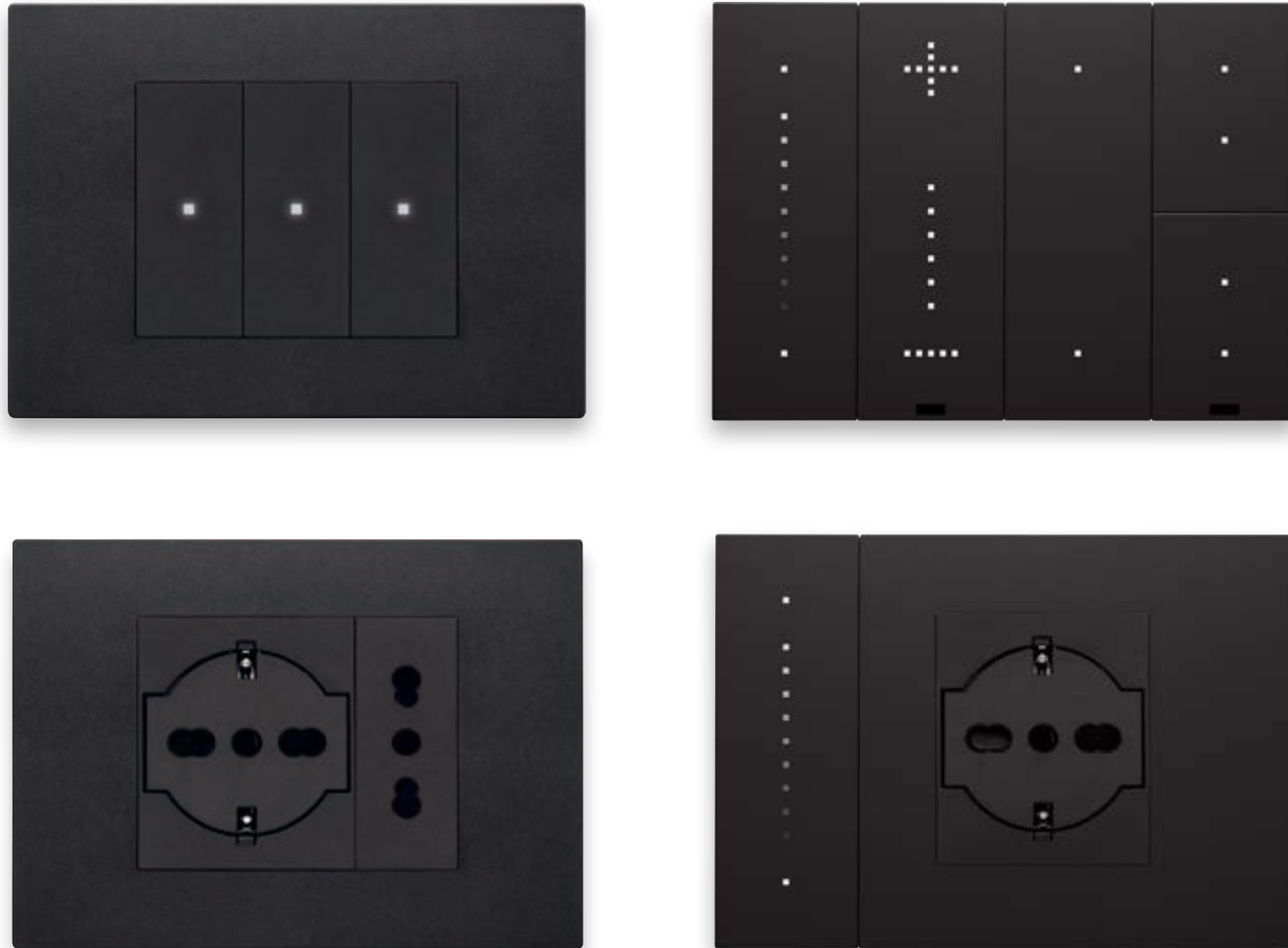

Painstaking pursuit of absolute flatness between all the elements of the lighting device and between different lighting devices. We have flattened what wasn't flat before: universal flush-fitting socket outlets with a patented recessed anti-jamming mechanism which guarantees functionality at every use and for every type of plug. Impeccable operation!

Linea and XT platform with control device and socket outlet device: perfectly matching all functions.



Impeccable coordination for an identity that stands out every time.

Understated and contemporary design and the pursuit of natural appeal have been interpreted by the neutral colour shades, which are growing in popularity in modern homes, creating welcoming atmospheres and easily accommodating various styles.

Pure, bright white brings to mind simple, open spaces; canvas is a warm and natural hue while black draws its inspiration from mineral materials, for settings with a bold personality.

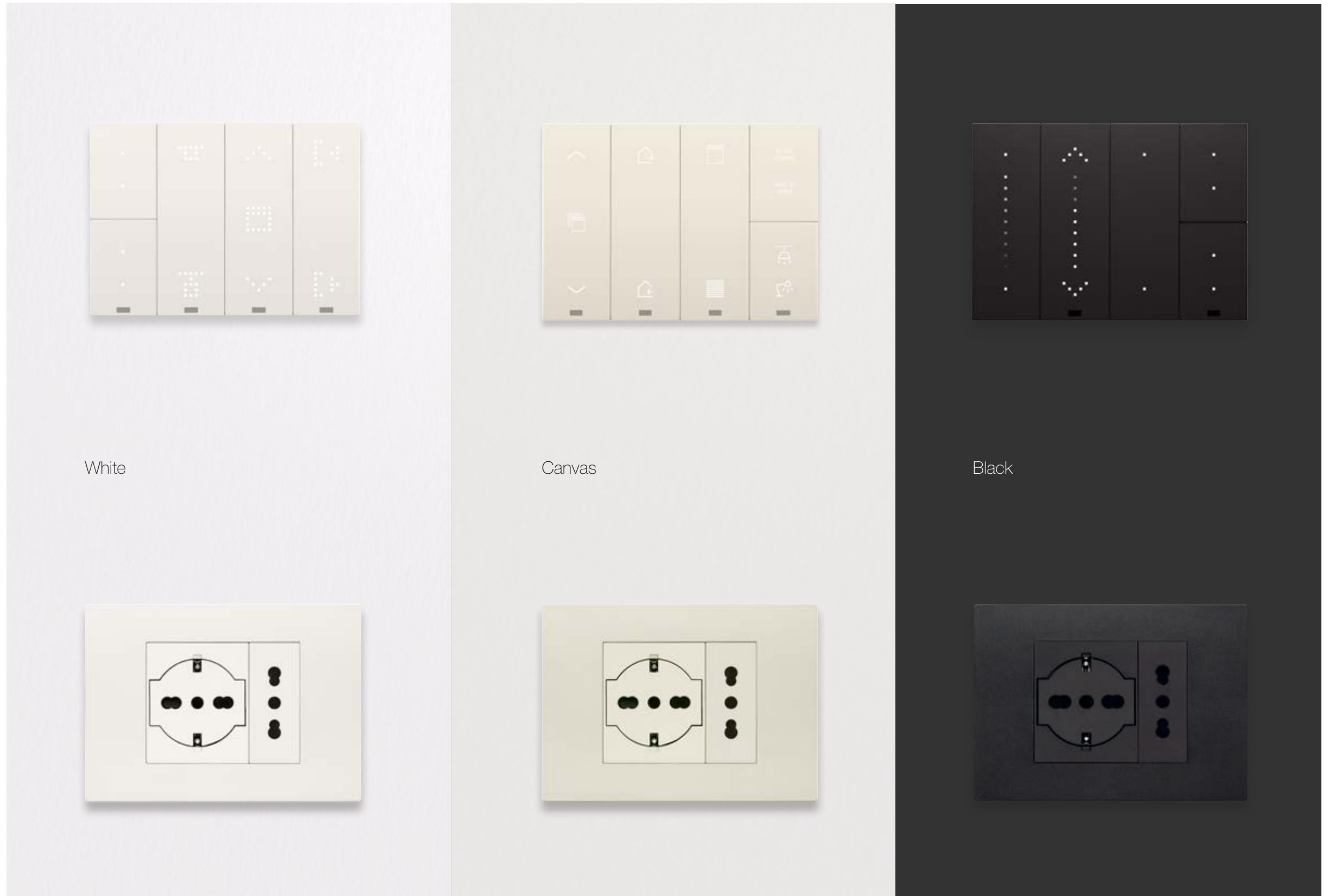

Living in a perfectly connected and integrated world.

With smart systems, home automation systems and over 200 functions to meet the needs for comfort, energy efficiency and safety of contemporary life.

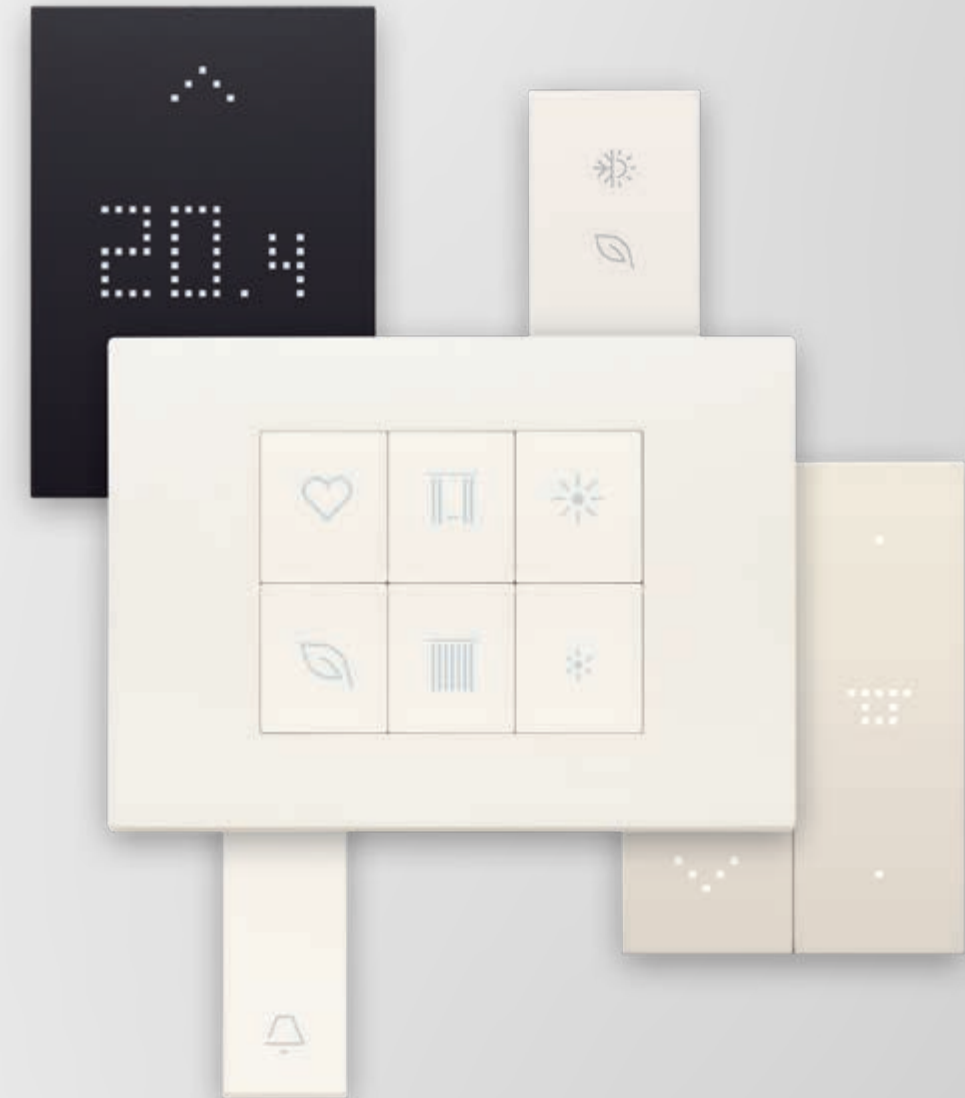

The home simply becomes smart.

Everything is under control via app or voice.

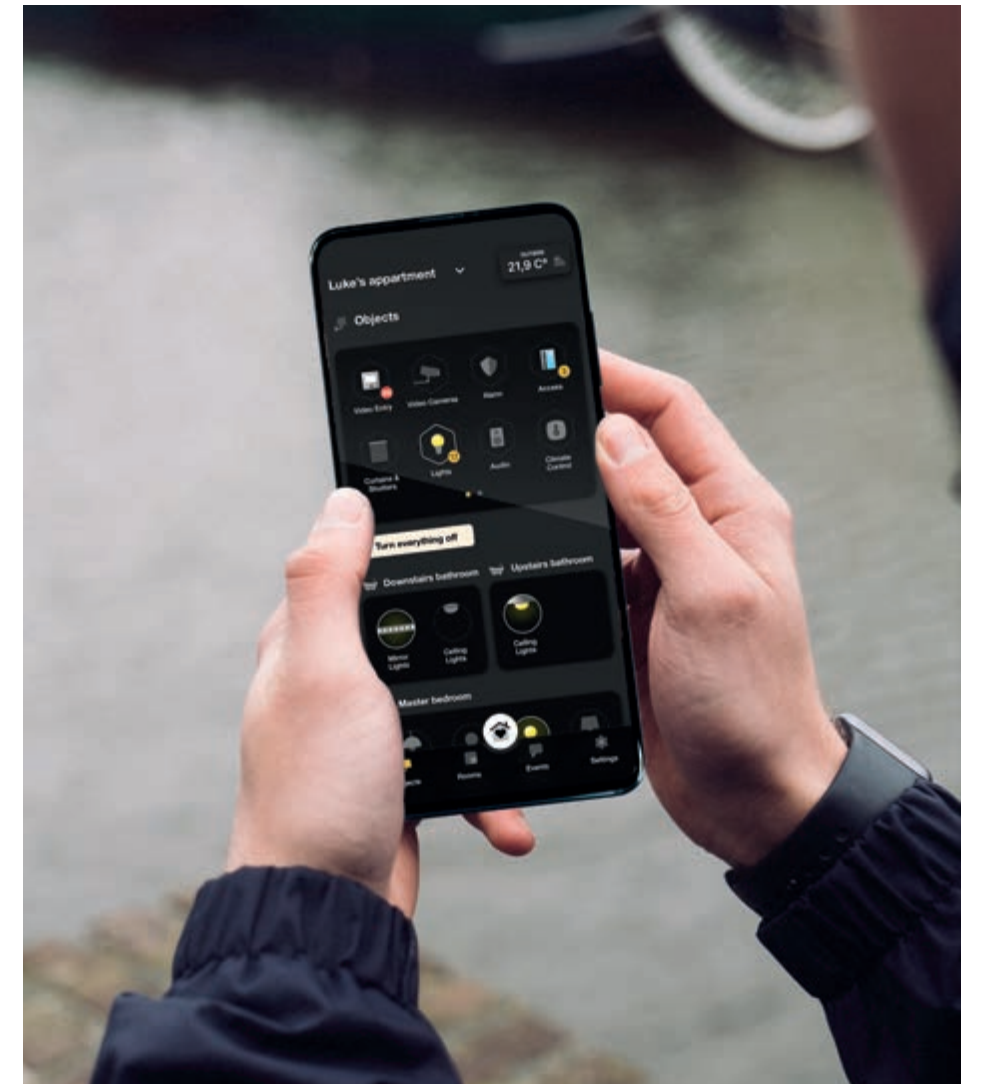
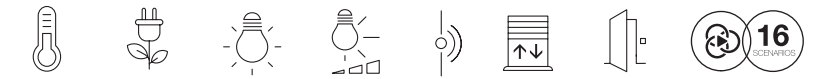
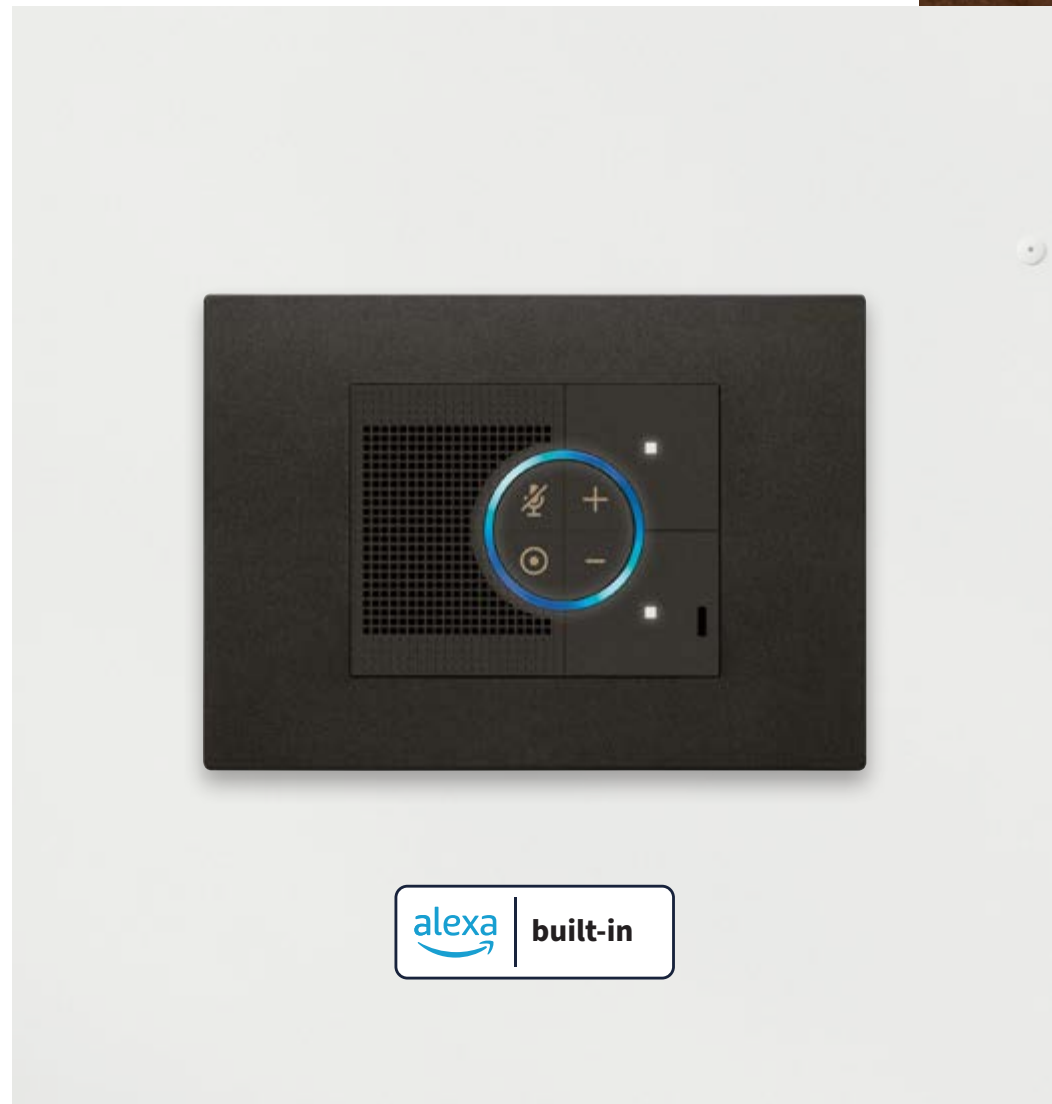

Thanks to the **View Wireless** system, you can control and even remote manage lights, roller shutters, the temperature in every room, accesses and energy consumption too. Greater comfort, efficiency and safety within the home and outside it too.

The connected wiring system is the ideal solution for refurbishments, to boost the functions of an existing system or in the event of a new system installation. Update spaces simply, no work required. The connected home improves life for its inhabitants.

Home automation and building automation system.

Linea and the XT platform: two different designs for a perfectly coordinated and matching home automation system.

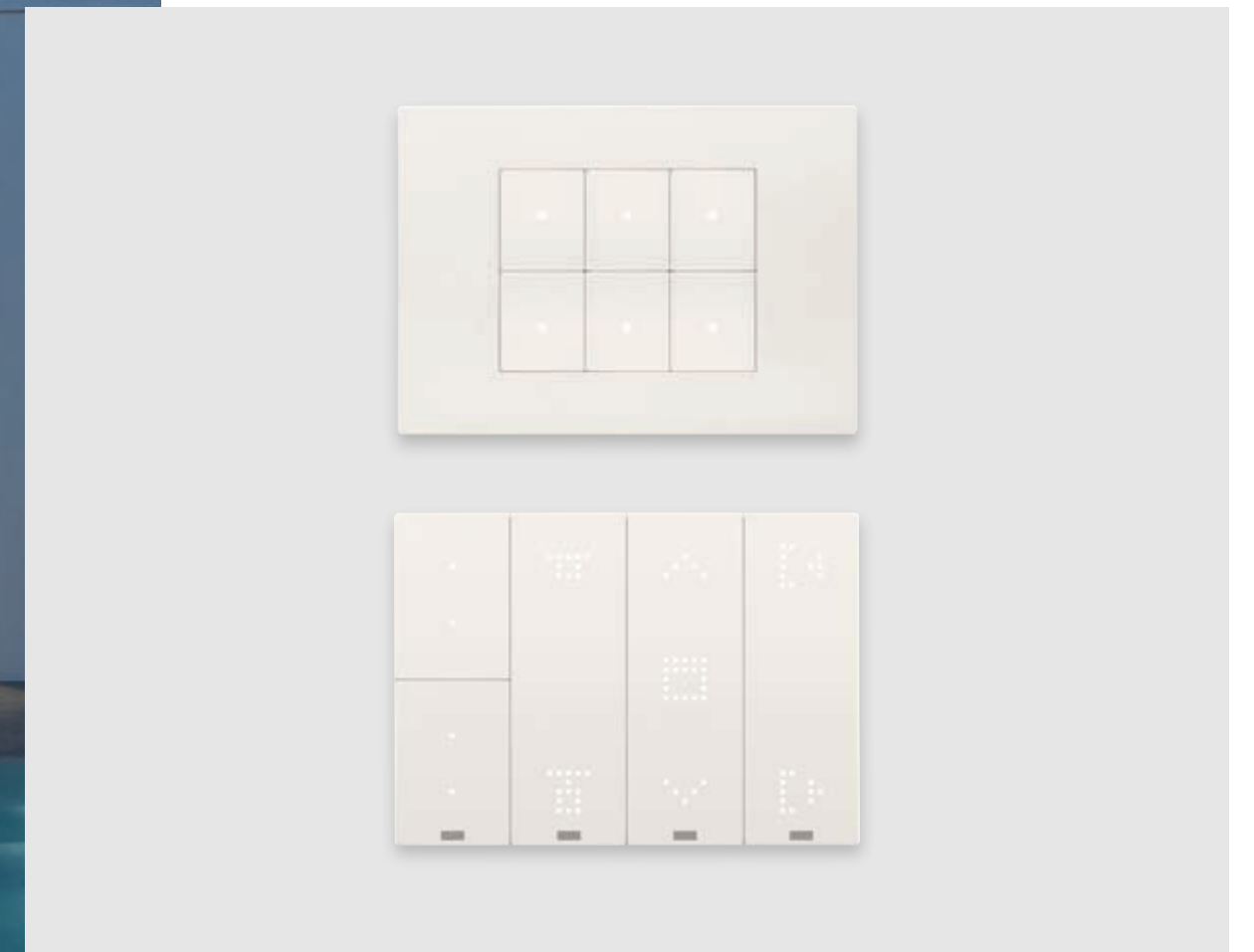
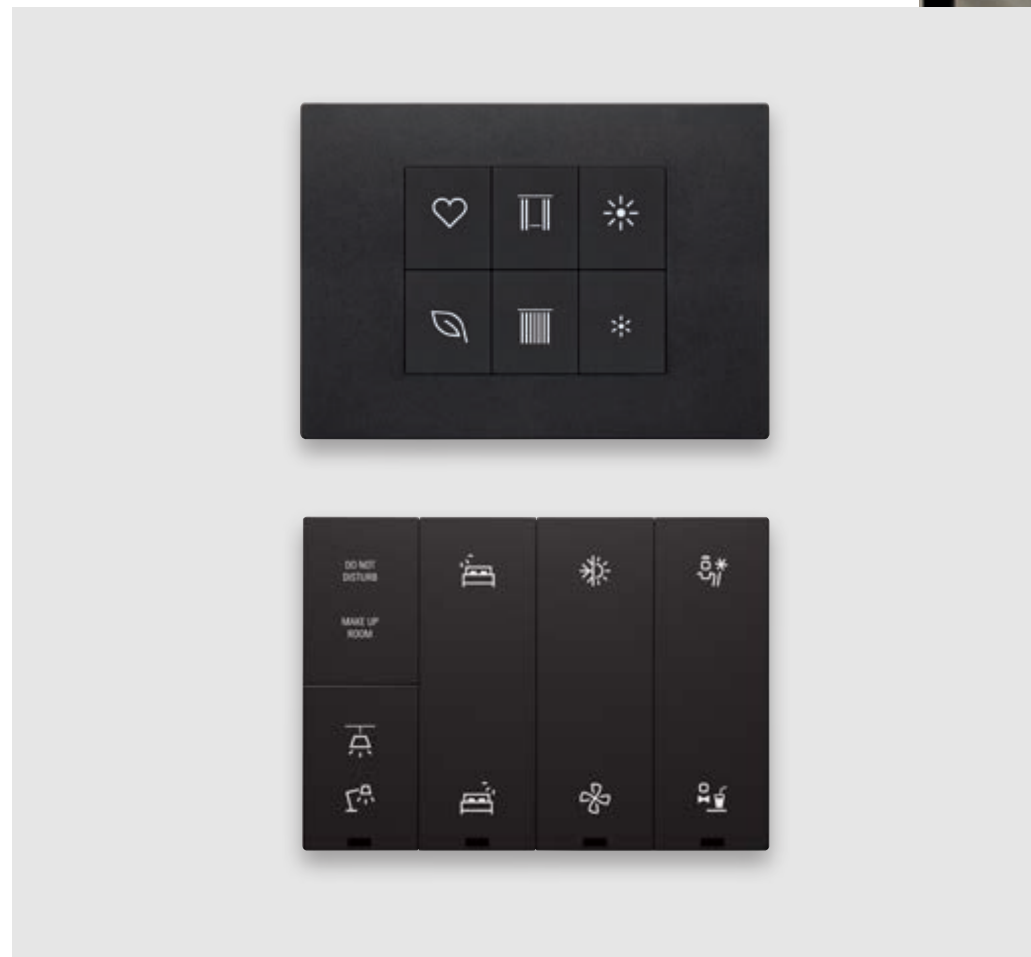

By-me Plus is the automation system which allows you to control lights, temperature, sound system, curtain and roller shutter automation, sprinkler system, energy management, multi-zone temperature and scenario control. Perfectly integrated with video door entry, burglar alarm and video surveillance systems, By-me Plus offers the utmost comfort, energy efficiency and superior safety in both home and office environments.



Flexible, interoperable and modular, **Well-contact Plus** is the system developed on the **KNX standard**, for complete building management. Whether in small or large hotels, offices, multi-purpose centres or even gyms, Well-contact Plus is the solution that provides constant control and management of lights, temperature, security, energy and accesses, providing functionality and comfort in every single environment.

Multiple functions thanks to Linea and the XT platform.

Over 200 functions to design a complete system with the utmost ease.

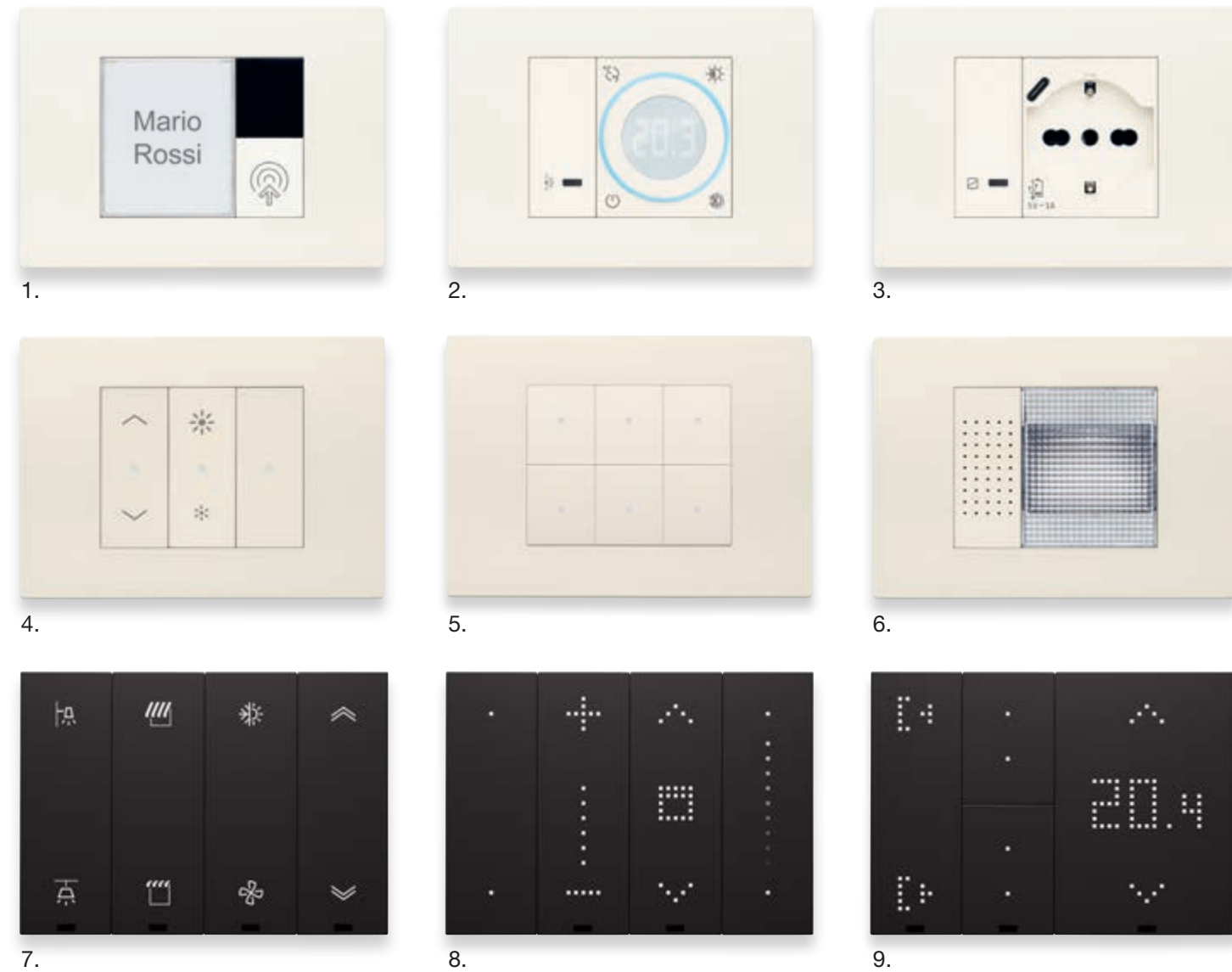

Functions key

- | | | |
|---|--|--|
| 1. Name plate push button and burglar alarm system actuator | 4. Controls compatible with various types of system: traditional, advanced and connected | 7. Controls with XT platform with customised labels |
| 2. Radar sensor and smart dial thermostat | 5. Home automation controls | 8. Controls with XT platform with dynamic LED matrix |
| 3. IoT connected actuator and universal socket outlet with type C USB | 6. Ringtone/buzzer with patent and auxiliary emergency removable hand lamp and controllable step marker lamp | 9. Thermostat and control with XT platform |



Highly versatile modular system.

Extremely flexible installation, also perfect for application in the hospitality industry and offices.



Functions key

- | | | |
|--|---|--|
| 1. Control for 2-module mounting box, between 1 and 12 programmable functions | 4. Room status signalling unit and bell | 7. Access point, Bpresa socket outlet, USB A+C TV socket outlets with 2 outputs, HDMI and RJ45 |
| 2. Control for 3-module mounting box, between 1 and 16 programmable functions | 5. DND/Make Up Room switch and transponder pocket | 8. 30 W USB socket outlet and universal flush-fitting socket outlet on table mounting box with adjustable height |
| 3. Controls for 4-module mounting box, between 1 and 20 programmable functions | 6. Auxiliary emergency and controllable step marker lamp, temperature probe and IR detector | |

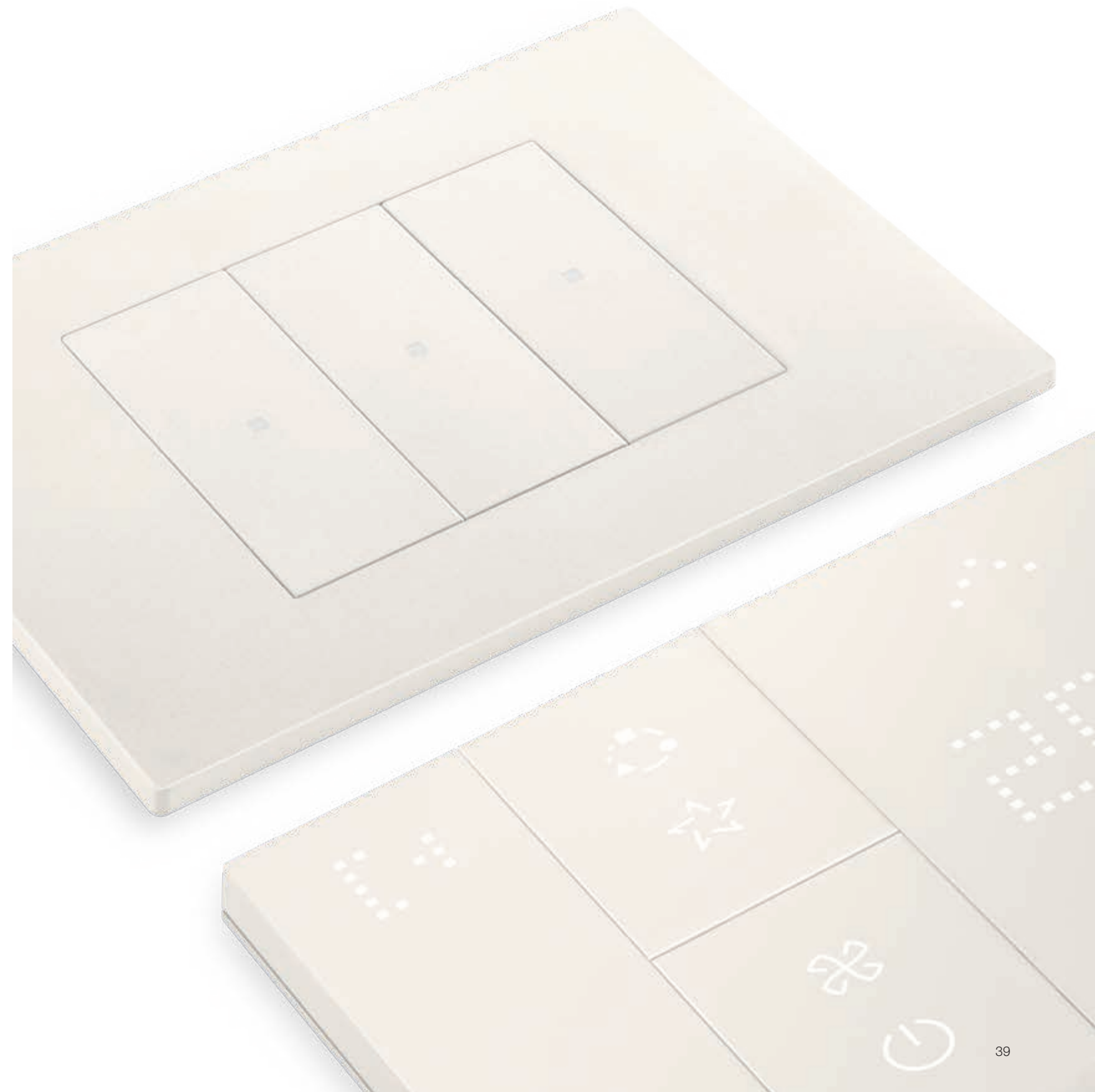

Attention to detail to give rise to bespoke projects.

Highly customisable controls to enhance the value of the project identity. An extensive range of symbols are available, to offer you the chance to customise environments and enhance the value of the facility's identity, whatever the facility.

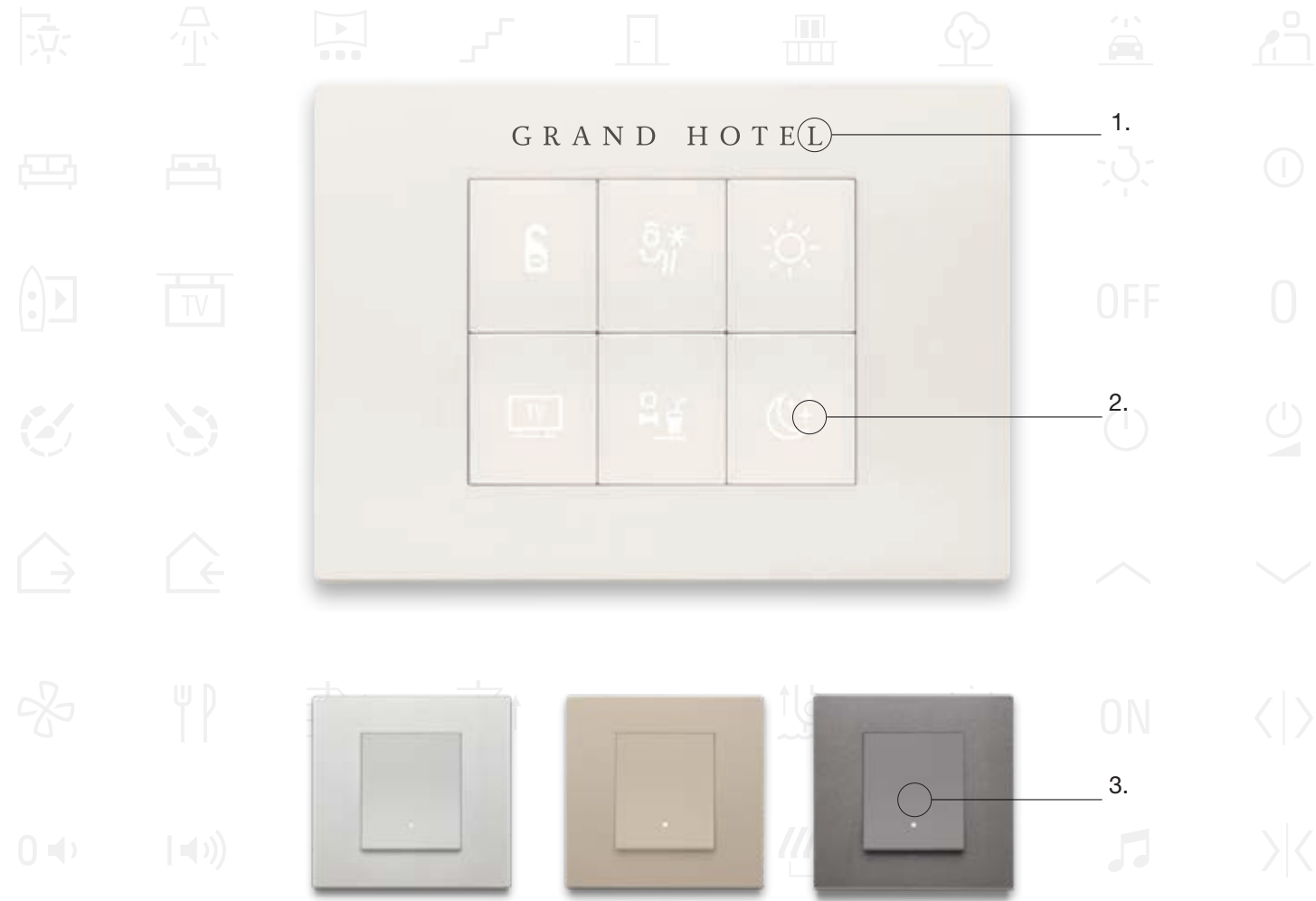

- 1. To enhance the value of an accommodation facility's identity, the cover plates can be engraved with the customer's own logo; laser technology ensures the symbols are clear and accurate.
- 2. Customised laser-engraved symbols, text and pictograms. Each customisation is reproduced in detail for lasting results and a further enhanced user experience.
- 3. For even more sophisticated solutions, controls and functions can be painted in the same colour as the painted technopolymer cover plates: silver, clay and metal - for the total look effect.

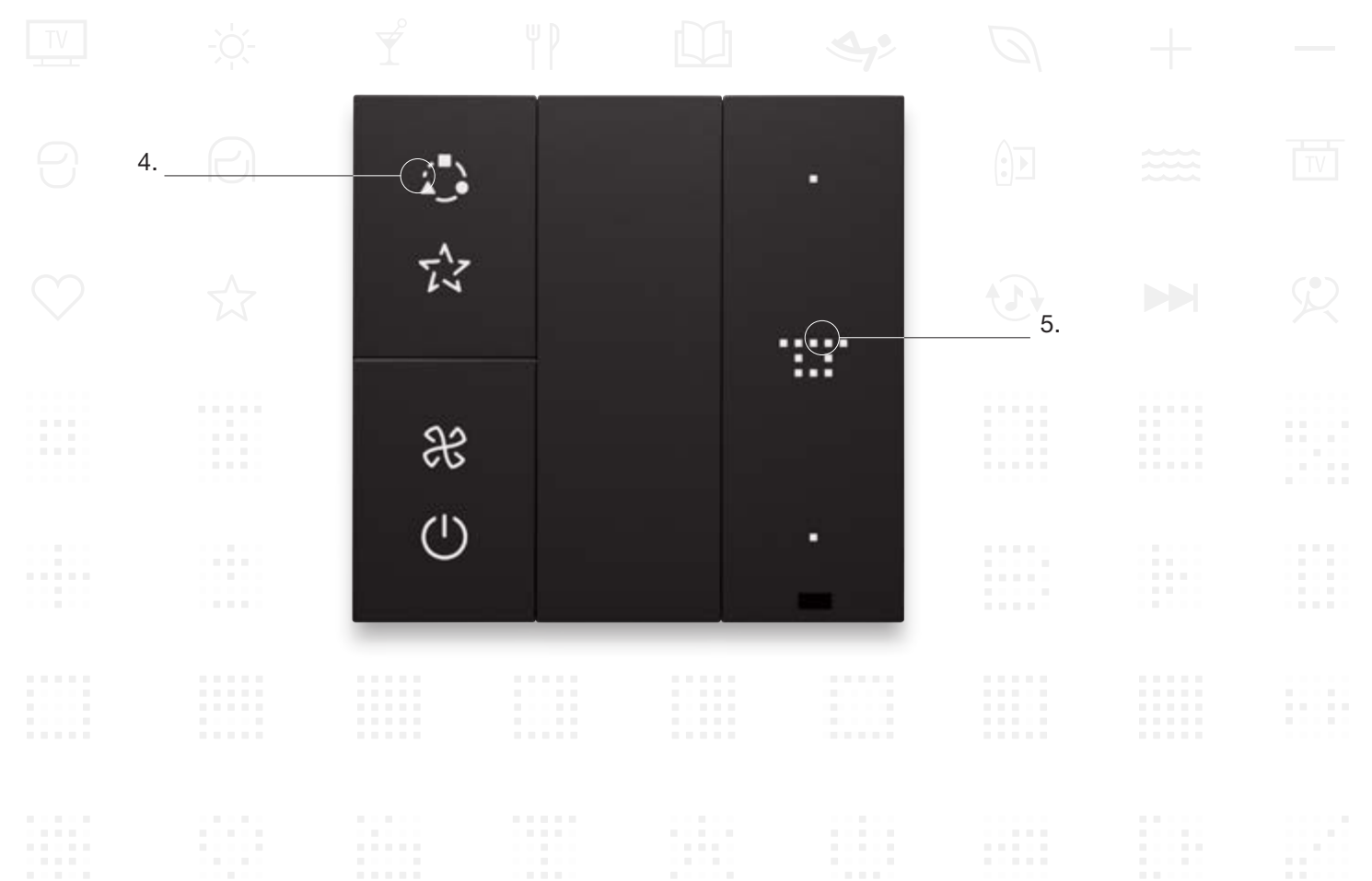

- 4. Laser-engraved graphic icons contained in a comprehensive and broad library of symbols, which allow you to identify the desired function.
- 5. Dynamic LED icons which can be customised using the View App. Possibility of smart backlighting with white light set to various brightness levels as you prefer.

Finishes, colours and materials for the home scenarios of today and tomorrow.



A range of carefully selected finishes.

Linea offers a range of cover plates designed to add value to any environment with a discrete style, paying particular attention to the choice of materials, including zinc-titanium alloy cover plates to obtain PVD finishes, with prestigious, eco-sustainable metallic effects.

Total look.
Perfectly matching styling for a unique style

Reflex.
Versatility and appeal thanks to the ultra realistic glass effect

Painted technopolymers.
The energy of modernity with simplicity and brilliance

PVD metals.
Zinc-titanium cover plates for high environmental performance PVD finishes



White that warms the surroundings

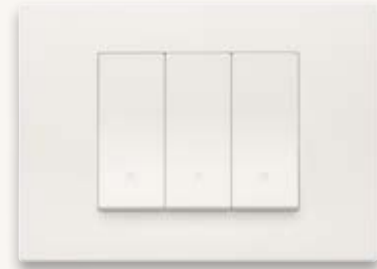

White

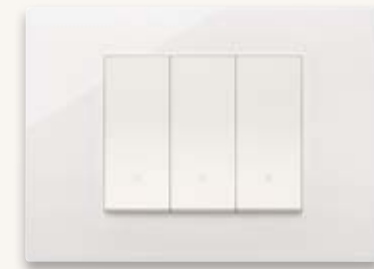

White Reflex

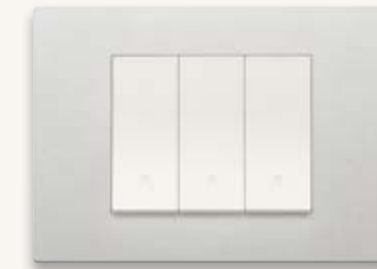

Silver



Brushed gold



Warm hues for trendy settings



Canvas



Canvas Reflex



Clay



Bronze



Black ambiances for bold environments



Black



Black Reflex



Metal



Satin finish stainless steel

Interior design trends.

The range of cover plate finishes available and the match with the colour of the control are the result of in-depth research into interior design trends, in order to be right on-trend and even anticipate future ones.

<p>Linear</p> <p>Contemporary Urban Zen Minimal Modern</p>				
<p>Retro</p> <p>Vintage New Déco Country Classic</p>				
<p>Fusion</p> <p>Nordic Shabby chic Boho chic Ethnic</p>				
<p>Eccentric</p> <p>Organic Industrial Decorative Pop</p>				

The emotional positioning of cover plates.

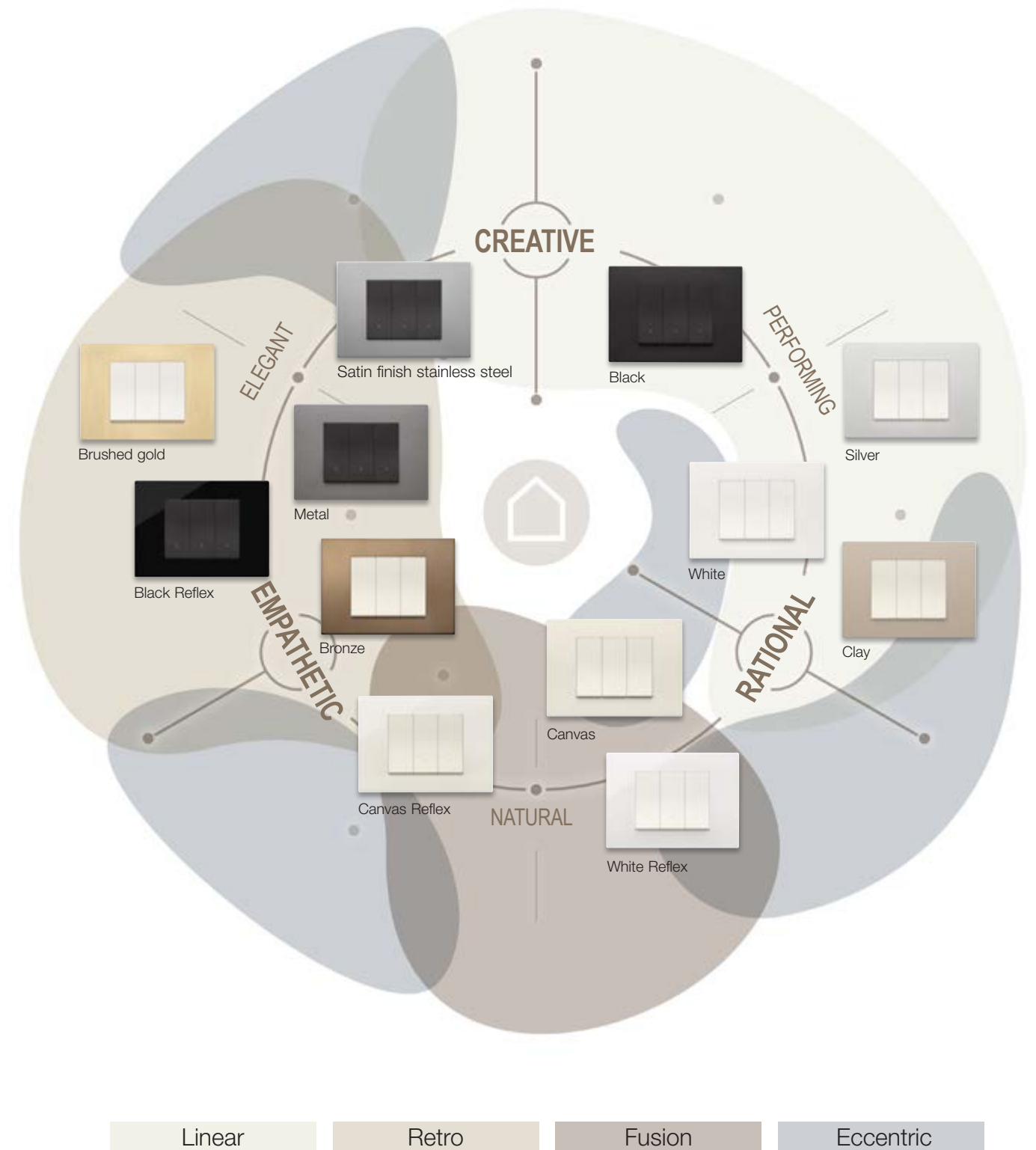

Shades of white to warm up the ambiance.

Finishes with pure and understated elegance.

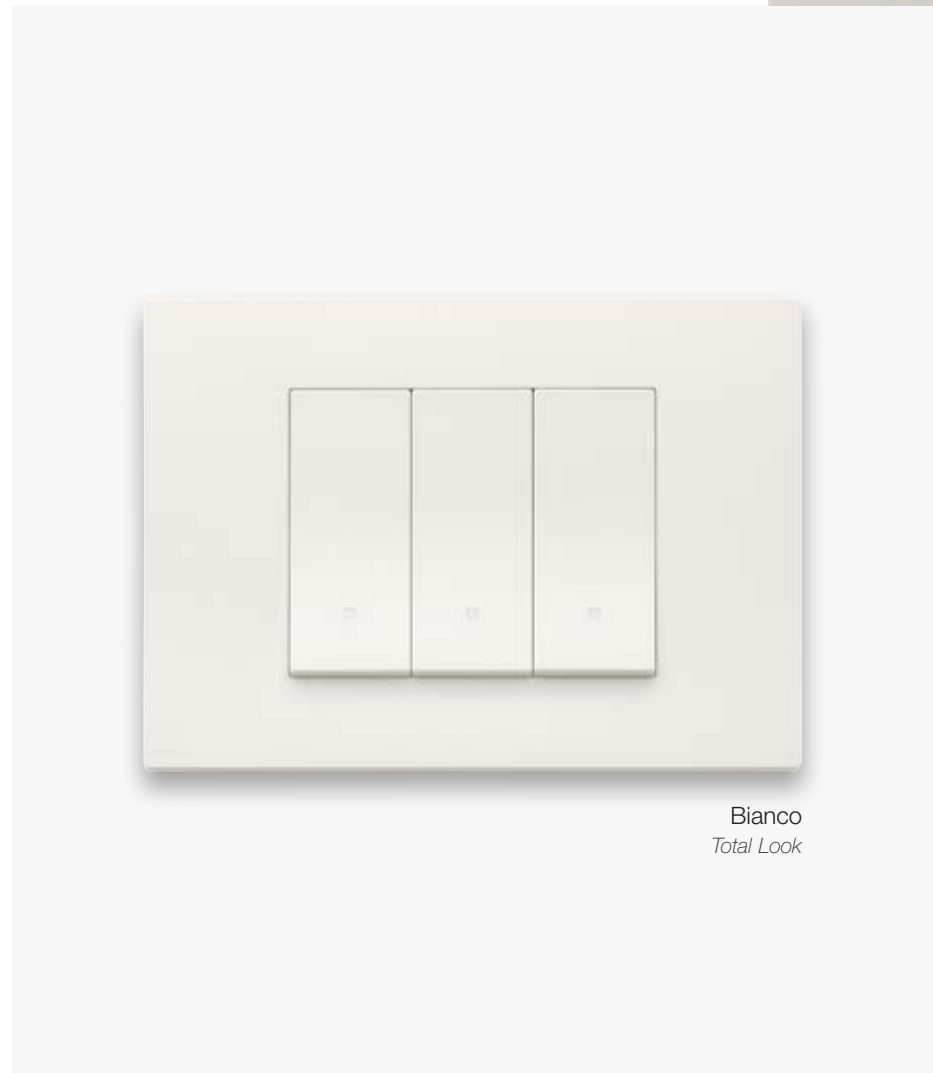

Bianco
Total Look

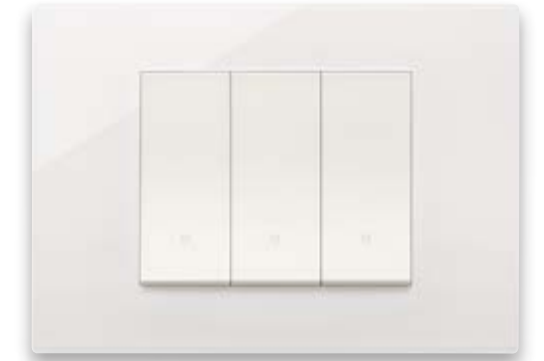

White Reflex
Glass effect

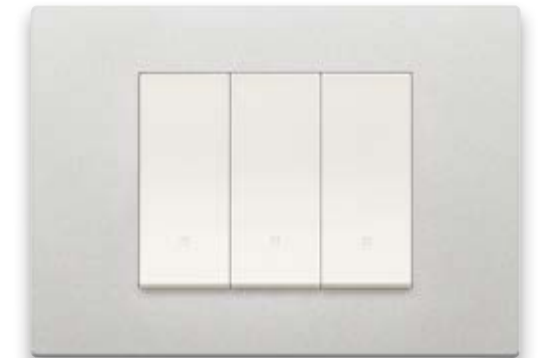

Silver
Painted technopolymer



Brushed gold
PVD metal

The natural appeal of canvas for trendy settings.

Delicate and understated hues.

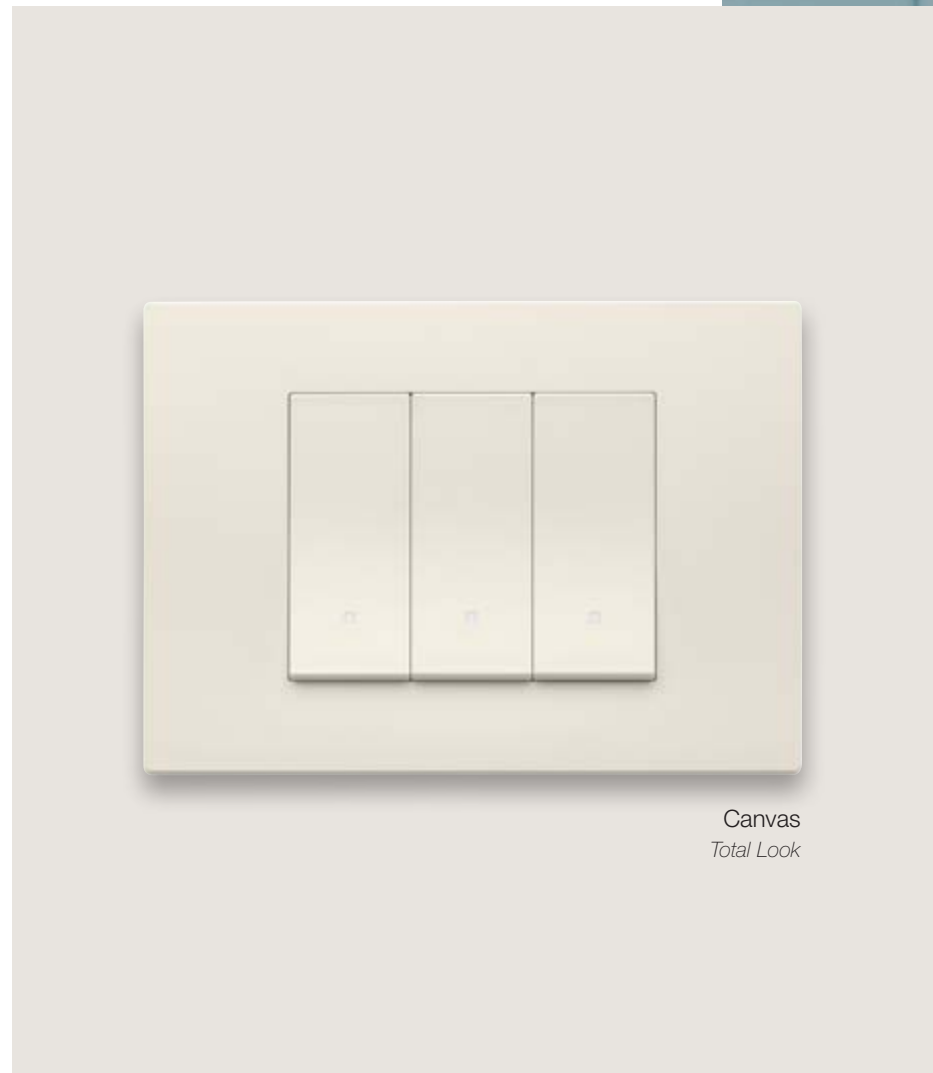

Canvas
Total Look



Canvas Reflex
Glass effect



Clay
Painted technopolymer



Bronze
PVD metal

Black for bold details.

Shades the bring out the modern, high-tech component.

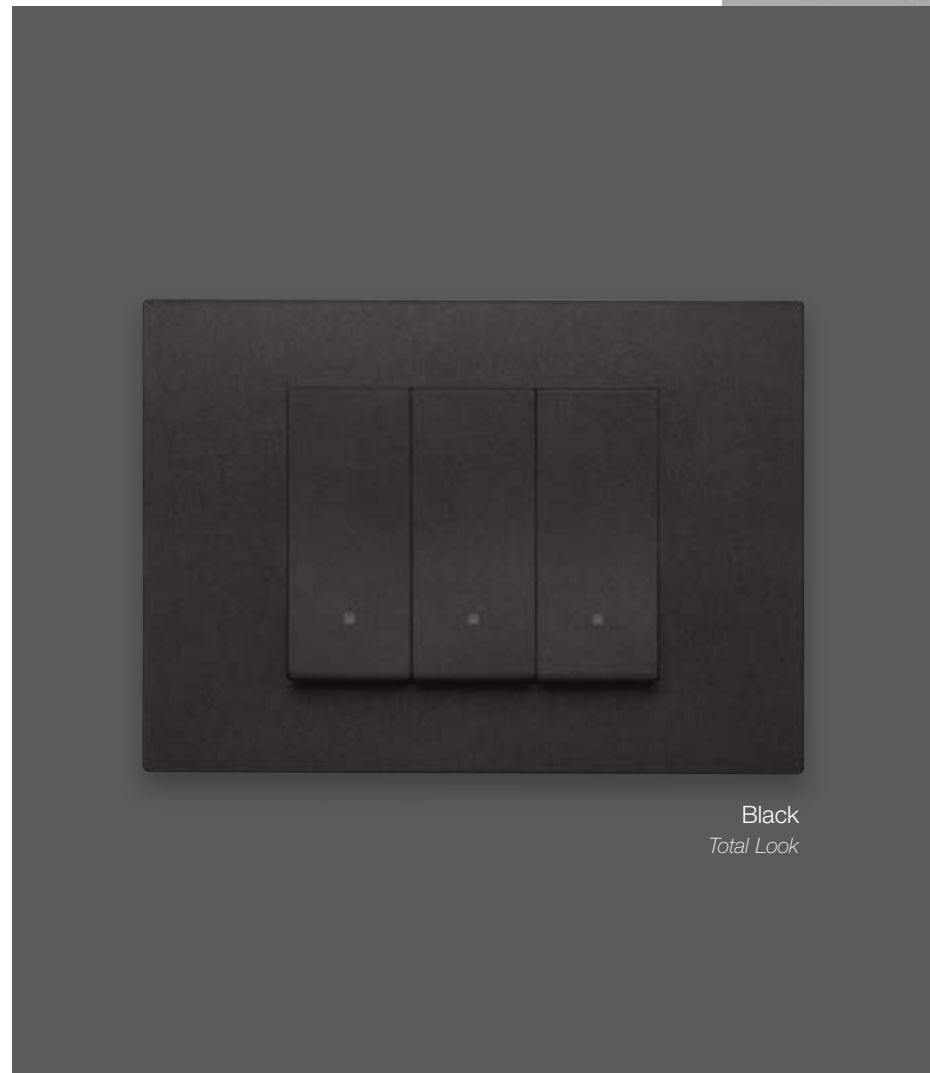

Black Reflex
Glass effect



Metal
Painted technopolymer



Satin finish stainless steel
PVD metal

Linea is designed to be sustainable and reduces CO₂ emissions by 80%

Thanks to the optimised production processes, the efficient management of product volumes and the use of FSC certified eco-sustainable packaging, a **reduction of CO₂ equivalent** produced by over 80% has been recorded. This translates to saving more than 500 tonnes of CO₂ equivalent by the end of 2024.

-80%
CO₂ eq. emissions

97% of Linea production contains plastic from renewable and recycled sources originating from an **ISCC PLUS** certified supply chain (mass balance, the certified portion varies for different products), contributing to the significantly lower environmental impact.



Finishing process for PVD (Physical Vapour Deposition) metal cover plates

Painstaking care taken with the choice of materials, including zinc-titanium alloy cover plates to achieve PVD finishes with prestigious, eco-sustainable metallic effects.



Eco-packaging

All Linea packaging is fully recyclable. Product cases, enclosures and boxes are made of recycled cardboard or card, printed with water-based ink. The paper used is FSC certified.



Products assessed according to the LCA approach

We assess the environmental performance of Vimar's high-turnover products according to the LCA (Life Cycle Assessment) approach, with respect to the international reference standards ISO 14040 and 14044. The process is part of the Environmental Product Declaration (EPD).

EPD-PEP Ecopassport certifications are available for all high-turnover products in the Linea, Eikon, Arké and Plana series and junction boxes; these are flagged with the relevant mark in every product sheet on www.vimar.com.

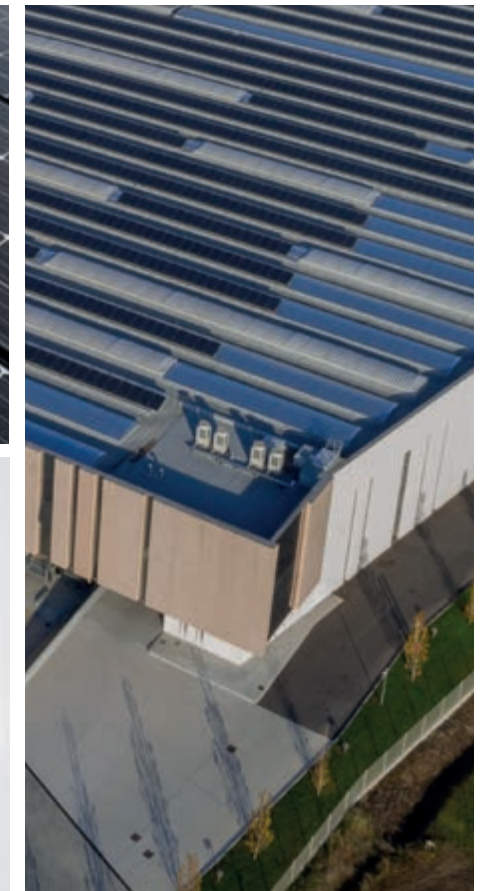

Renewable energy.

For the supervision and analysis of energy consumption levels in our plants, we have adopted the logic of smart metering. Our new logistics and production pole has been fitted with an open-circuit geothermal system, 3000 square metres of prefabricated biodynamic cement panels (corresponding to the planting of 250 trees), while the roof of the building has been covered by a 3,900 m² photovoltaic system which meets 30% of energy consumption requirements. These design choices show sustainability, architectural value and occupational comfort expressed to the full.

LINEA

Design	01
Systems	30
Functions	36
Bespoke projects	40
Living styles	42
Sustainability	54

100% Made in Italy

B D23002 EN 2301
8 007352 172738 0

Energia Positiva. Insieme



Viale Vicenza, 14 36063 Marostica VI - Italy Tel. +39 0424 488 600 www.vimar.com